

EXECUTIVE SERIES

STANDARD
DETAILS



Executive Series Drawing Index

Elevations	E0-0-1.dwg	Sample Elevation 1
	E0-0-2.dwg	Sample Elevation 2
	E0-0-3.dwg	Sample Elevation 3
Standard Vertical Joint Details	E1-1-1.dwg	Solid Frame / Solid Frame Detail
	E1-1-2.dwg	Glass Frame / Solid Frame Detail
	E1-1-3.dwg	Hinged Door Frame / Solid Frame Detail
	E1-1-4.dwg	Glass Frame / Glass Frame Detail
	E1-1-5.dwg	Hinged Door Frame / Glass Frame Detail
	E1-1-6.dwg	Hinged Door Frame / Double Glass Frame Detail
Standard Top Details	E2-1-1.dwg	Solid Panel at Ceiling (Standard)
	E2-1-2.dwg	Glass Panel at Ceiling (Standard)
	E2-1-3.dwg	Hinged Door Frame at Ceiling (Standard)
	E2-1-4.dwg	Double Glazing Panel at Ceiling (Standard)
Standard Base Trim Details	E3-1-1.dwg	Solid Panel at Floor (Standard)
	E3-1-2.dwg	Glass Panel at Floor (Standard)
	E3-1-3.dwg	Hinge Door Panel at Floor (Standard)
	E3-1-4.dwg	Double Glazed Panel at Floor (Standard)
Solid Panel to Walls Conditions	E4-1-1.dwg	Solid Frame Wall Start Detail (Standard)
	E4-1-2.dwg	End Cap / Glass Panel Detail (Standard)
	E4-1-3.dwg	End Cap / Door Frame Detail (Standard)
	E4-1-4.dwg	End Cap / Door Frame Detail at Corporate (Standard)
Wall End Conditions	E4-2-1.dwg	Aluminum End Cap / Solid Panel Termination
	E4-2-2.dwg	Aluminum End Cap / Glass Panel Termination
3-Way Connections	E5-1-1.dwg	3-Way Post - Solid / Solid / Solid (Standard)
	E5-1-2.dwg	3-Way Post - Door / Glass / Solid (Optional)
90° Corner Posts	E5-2-1.dwg	90° Corner Post - Solid Panel / Glass Panel
	E5-2-2.dwg	90° Corner Post - Solid Panel / Door Panel
135° Corner Posts	E5-3-1.dwg	135° Corner Post - Solid-Glass (Typical)
	E5-3-2.dwg	135° Corner Post - Solid-Door (Typical)
	E5-3-3.dwg	135° Corner Post - Solid-Solid (Typical)
Glass Sliding door Details	E6-1-1.dwg	Glass Sliding Door on Flat Door Frame at Floor
	E6-1-2.dwg	Glass Sliding Door / Solid Panel at Floor
	E6-1-3.dwg	Glass Sliding Door on Glass at Floor
	E6-1-4.dwg	Glass Sliding Door / Outside Jamb
	E6-1-5.dwg	Glass Sliding Door on Solid at Ceiling
	E6-1-6.dwg	Glass Sliding Door on Glass at Ceiling
Stacked & Rail Height Panel Details	E7-1-1.dwg	Aluminum Top Cap / Solid Panel
	E7-1-2.dwg	Aluminum Top Cap / Glass Panel
	E7-1-3.dwg	Aluminum Top Cap / Door Panel
	E7-1-4.dwg	Glass Sliding Door - Aluminum Top Cap / Solid Panel
	E7-1-5.dwg	Glass Sliding Door - Aluminum Top Cap / Glass Panel
	E7-1-6.dwg	Glass Sliding Door - Aluminum Top Cap / Door Panel
Stacked & Rail Height Panel Details	E7-2-1.dwg	Stacked Panel - Solid Above Solid

E7-2-2.dwg	Stacked Panel - Solid Above Glass
E7-2-3.dwg	Stacked Panel - Solid Above Door
E7-2-4.dwg	Stacked Panel - Glass Above Solid
E7-2-5.dwg	Stacked Panel - Glass Above Glass
E7-2-6.dwg	Stacked Panel - Glass Above Door

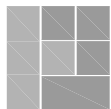
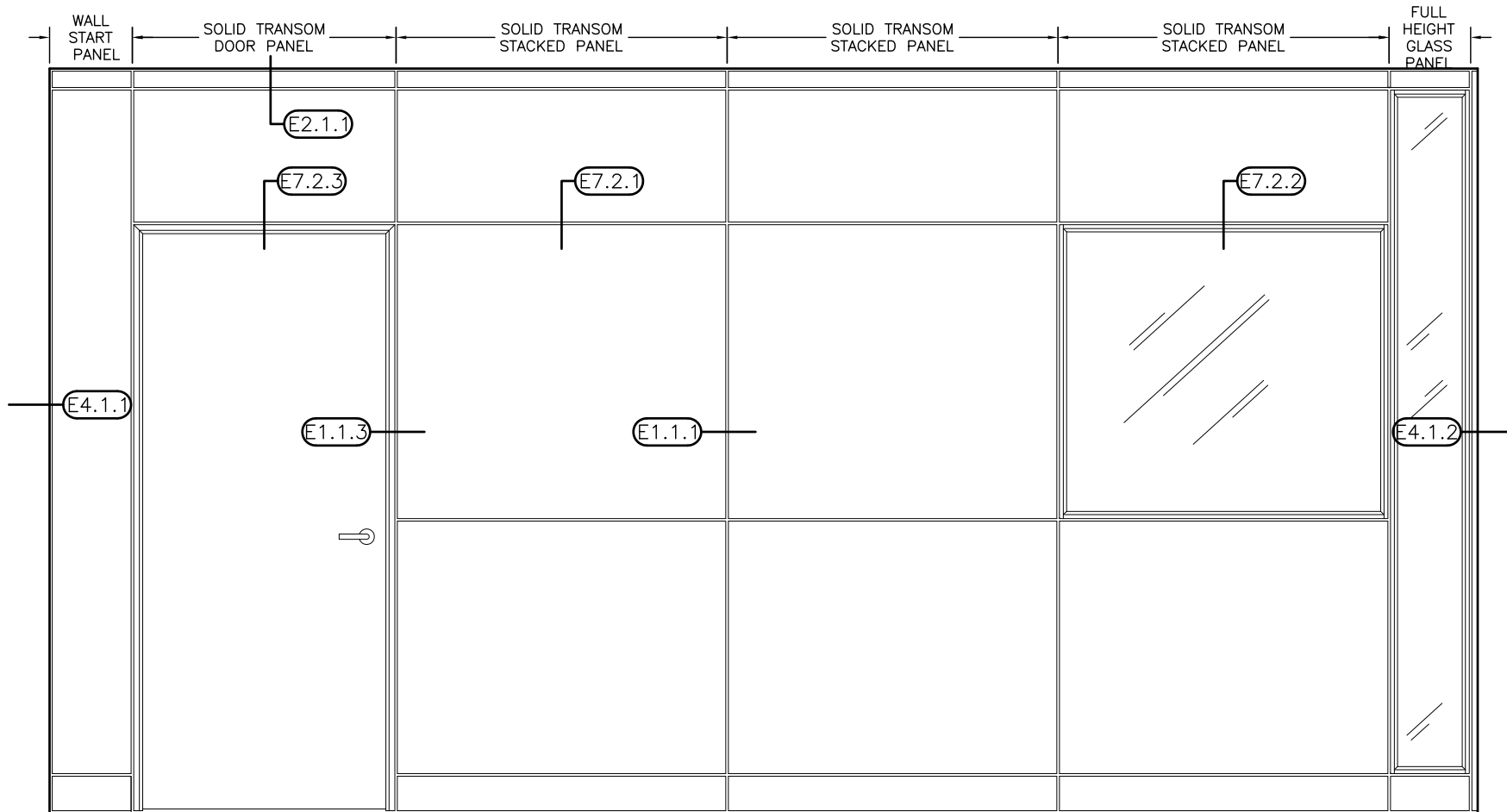

**PARTITION
SYSTEMS**

SAMPLE ELEVATION

DWG:

E0.0.1

FILE: E0-0-1.DWG

SCALE: 1/2" = 1'

DATE: NOV 2008

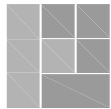
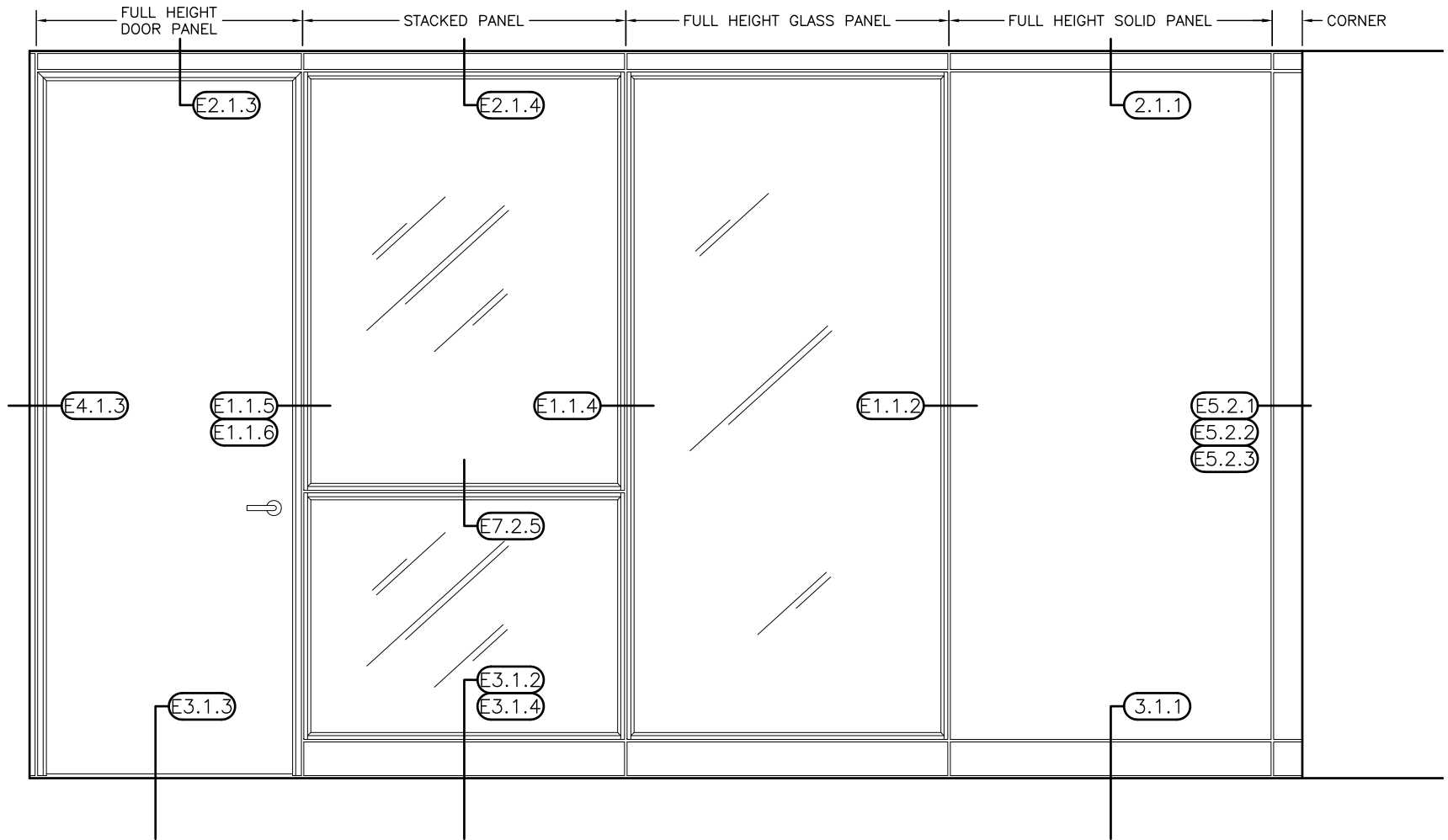

**PARTITION
SYSTEMS**

SAMPLE ELEVATION

DWG:

E0.0.2

FILE: E0-0-2.DWG

SCALE: 1/2" = 1'

DATE: NOV 2008

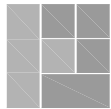
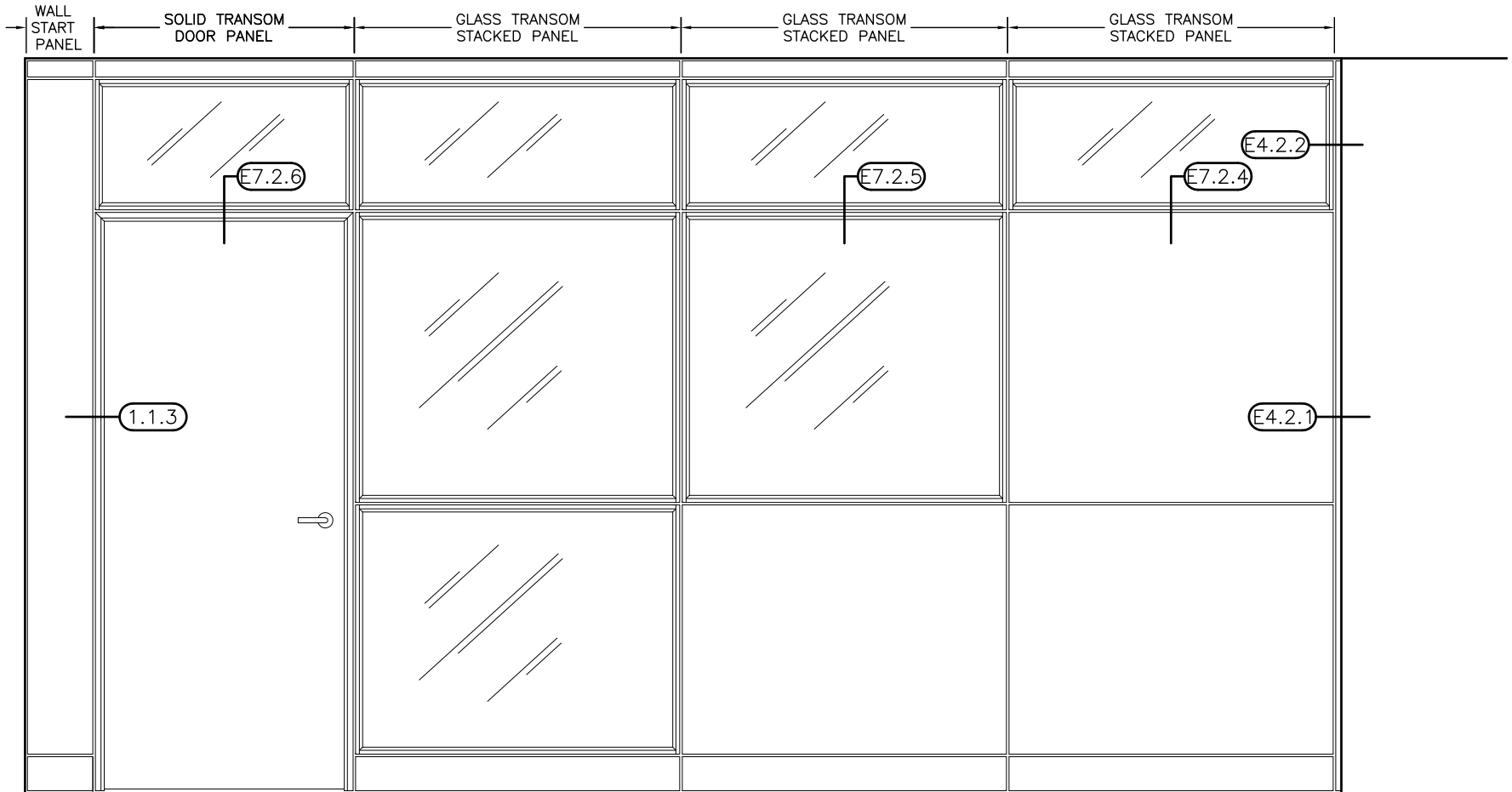

**PARTITION
SYSTEMS**

SAMPLE ELEVATION

DWG:

E0.0.3

FILE: E0-0-3.DWG

SCALE: 1/2" = 1'

DATE: NOV 2008

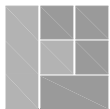
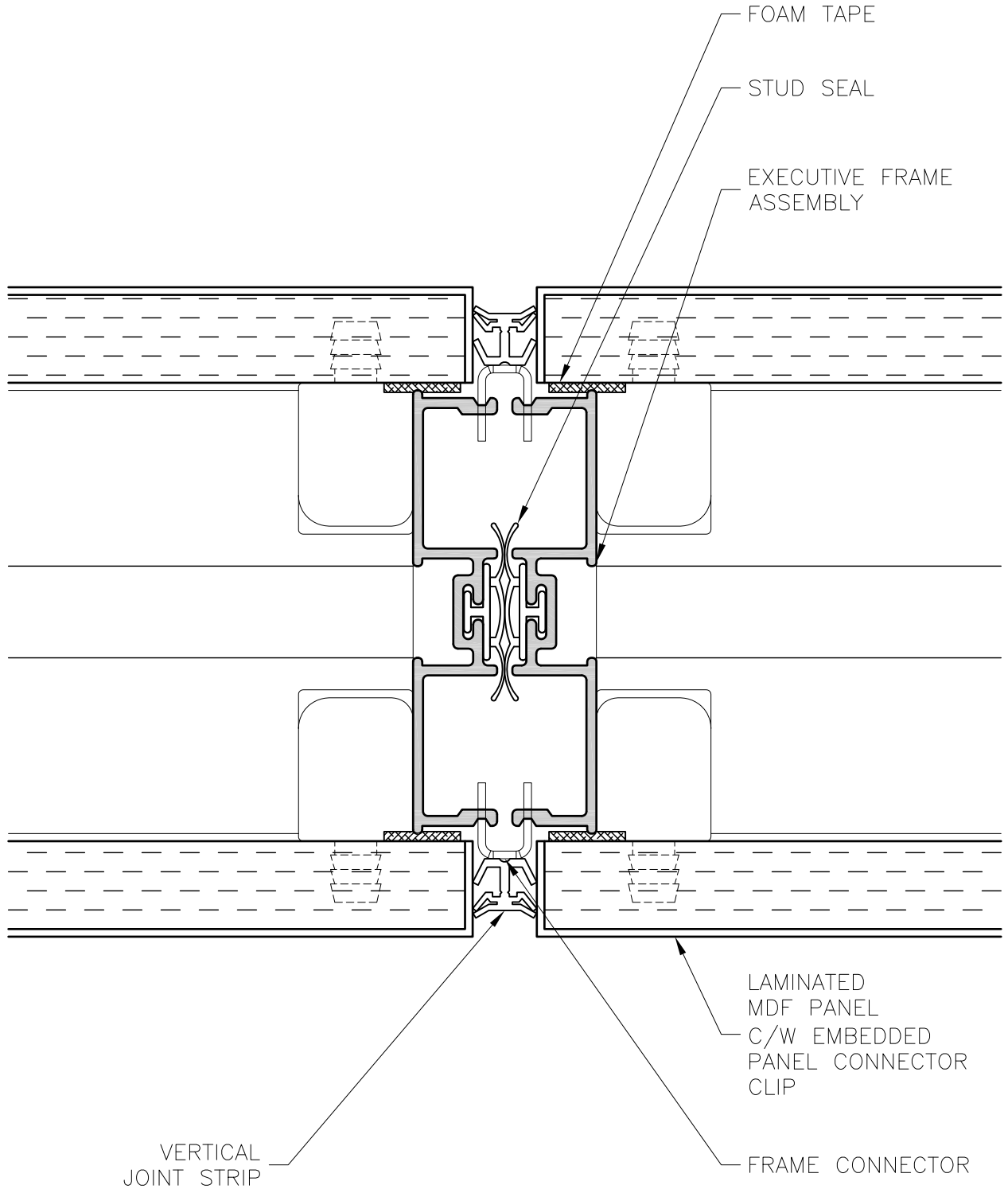

**PARTITION
SYSTEMS**

SOLID FRAME
SOLID FRAME
DETAIL

DWG:

E1.1.1

FILE: E1-1-1.DWG

SCALE: 1 : 1

DATE: NOV 2008

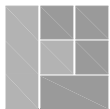
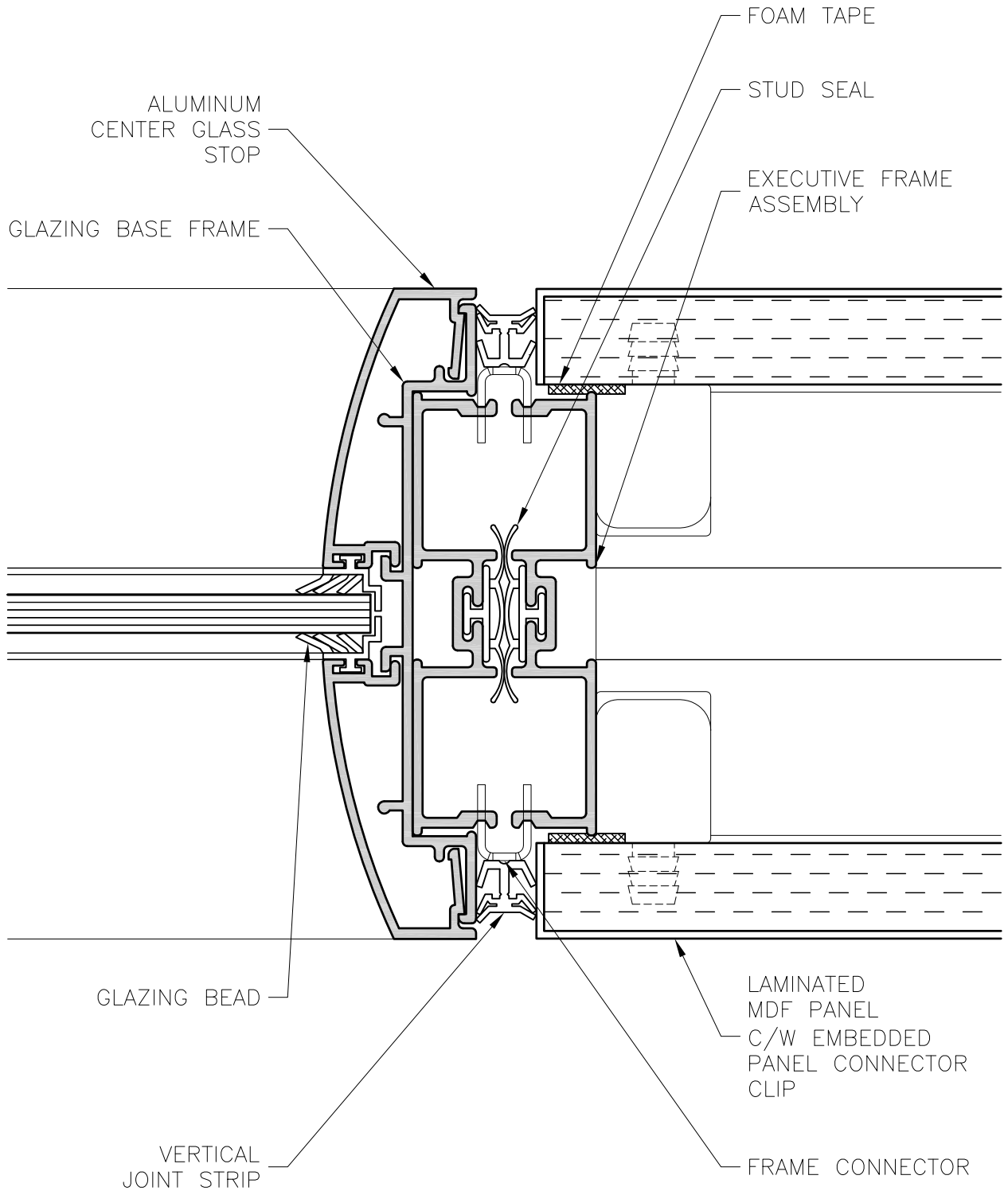

**PARTITION
SYSTEMS**

GLASS FRAME
SOLID FRAME
DETAIL

DWG:

E1.1.2

FILE: E1-1-2.DWG

SCALE: 1 : 1

DATE: NOV 2008

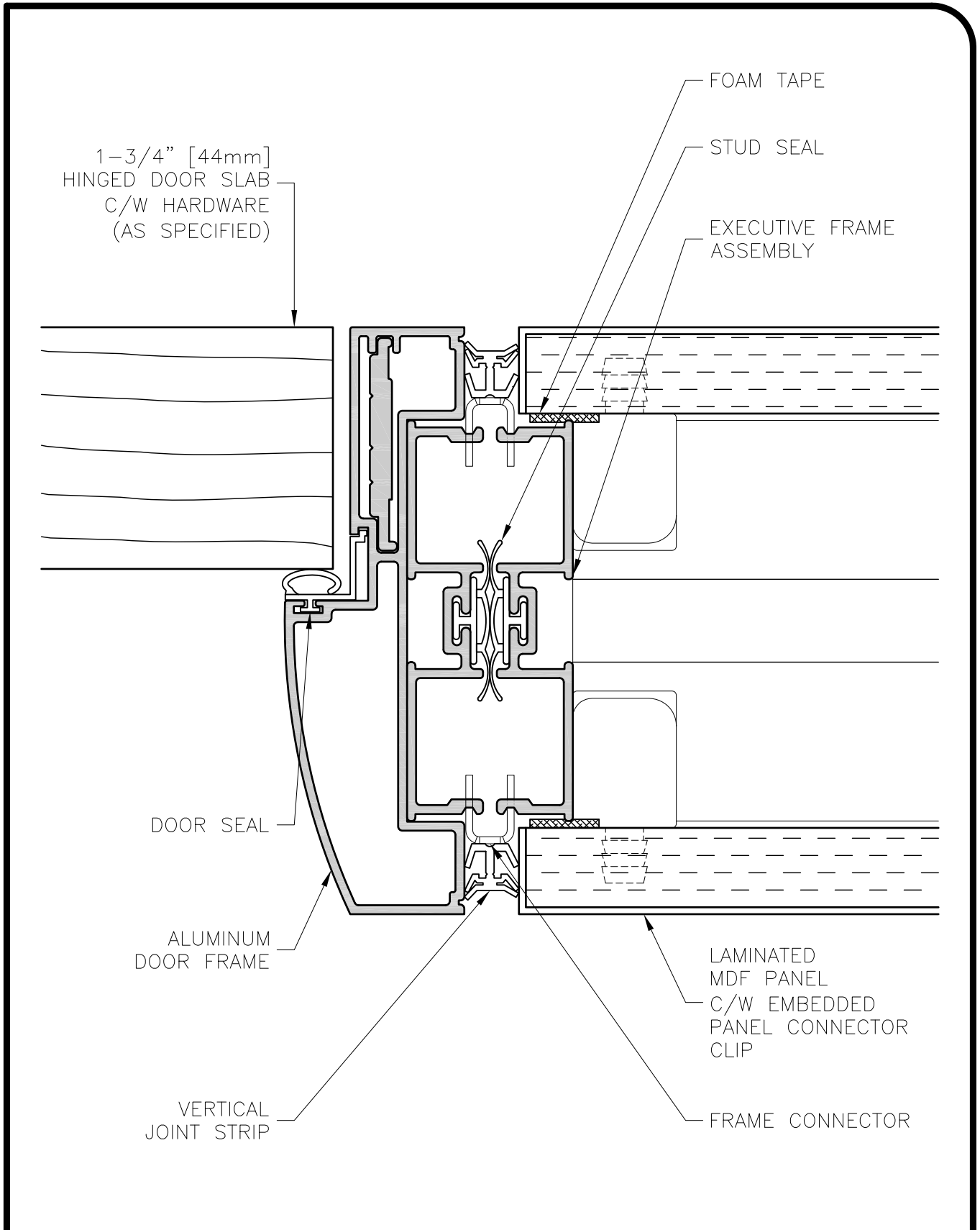

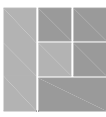
 PARTITION SYSTEMS	HINGED DOOR FRAME SOLID FRAME DETAIL	DWG: E1.1.3
FILE: E1-1-3.DWG	SCALE: 1 : 1	DATE: NOV 2008

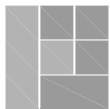
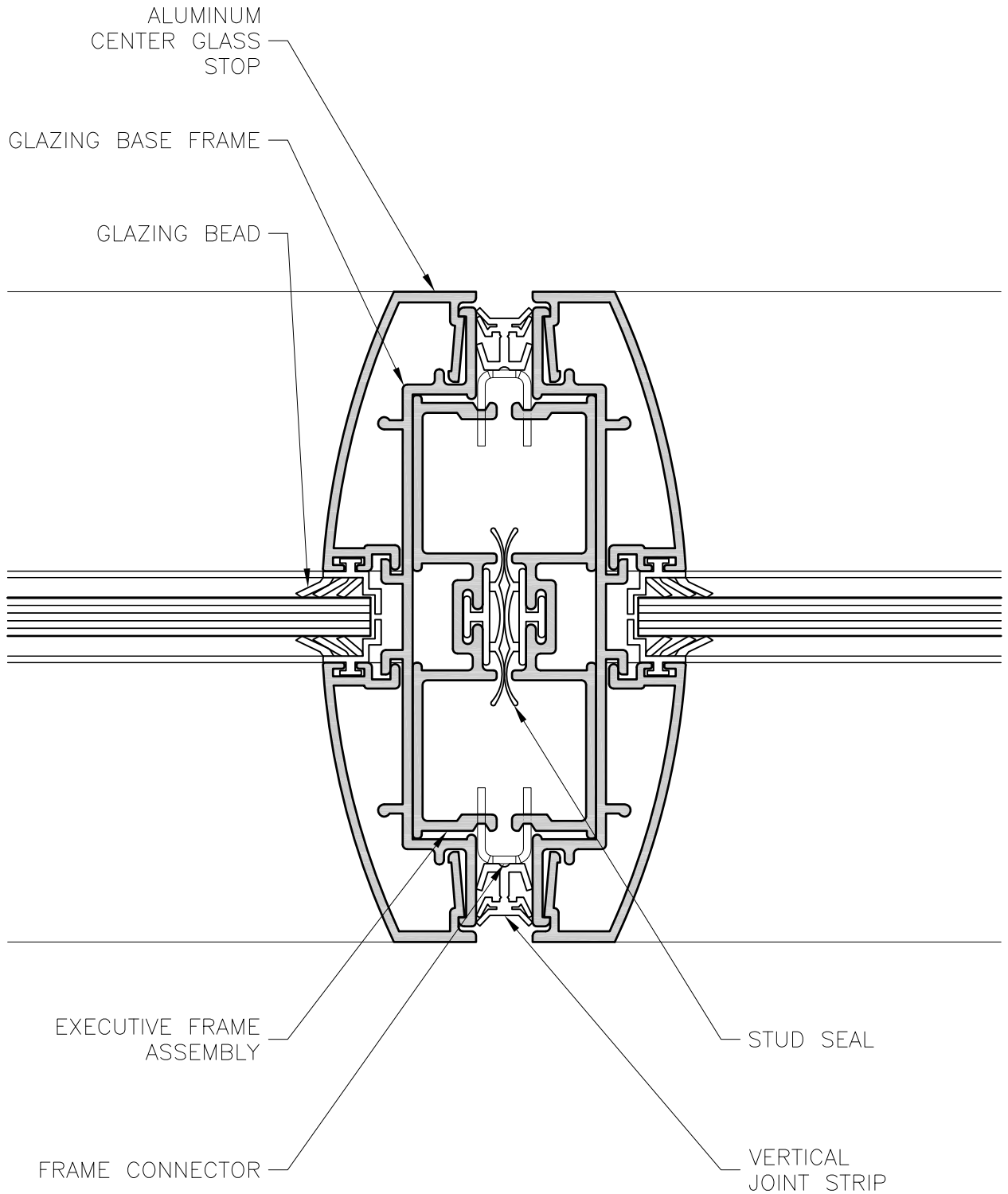

**PARTITION
SYSTEMS**

GLASS FRAME
GLASS FRAME
DETAIL

DWG:

E1.1.4

FILE: E1-1-4.DWG

SCALE: 1 : 1

DATE: NOV 2008

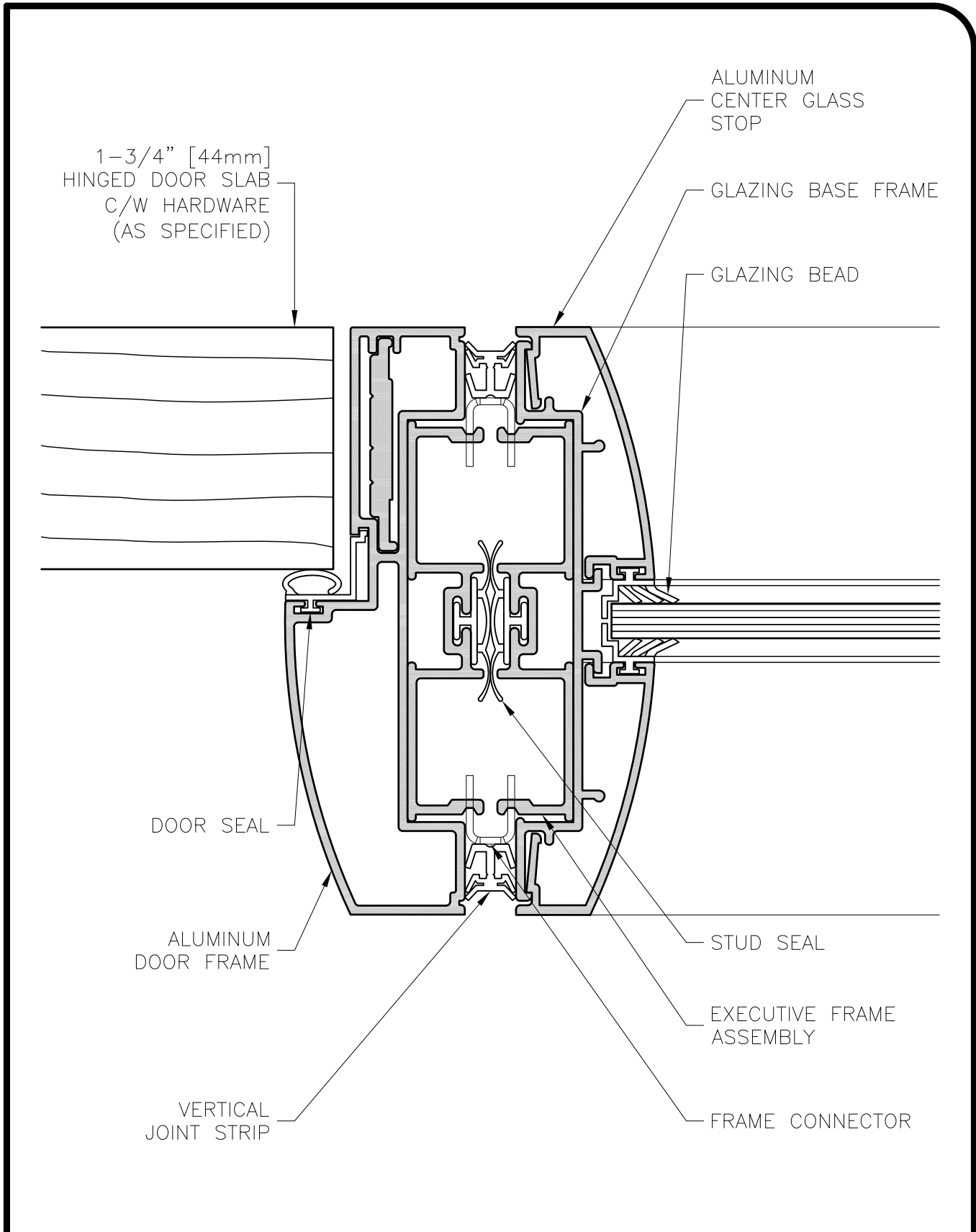

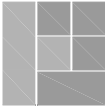
 PARTITION SYSTEMS	HINGED DOOR FRAME GLASS FRAME DETAIL	DWG: E1.1.5
FILE: E1-1-5.DWG	SCALE: 1 : 1	DATE: NOV 2008

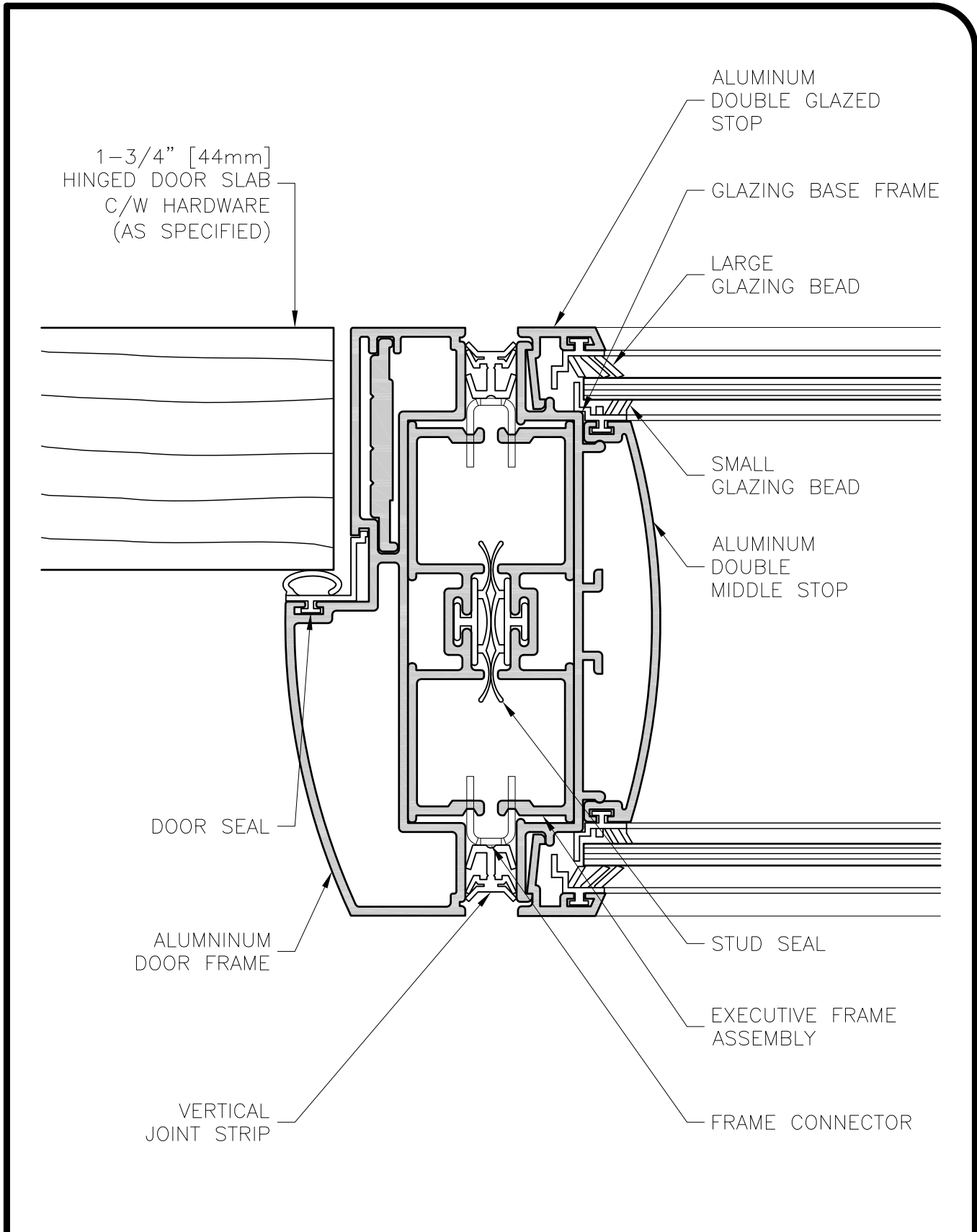

 PARTITION SYSTEMS	HINGED DOOR FRAME DOUBLE GLASS FRAME DETAIL	DWG: E1.1.6
FILE: E1-1-6.DWG	SCALE: 1 : 1	DATE: NOV 2008

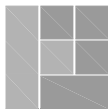
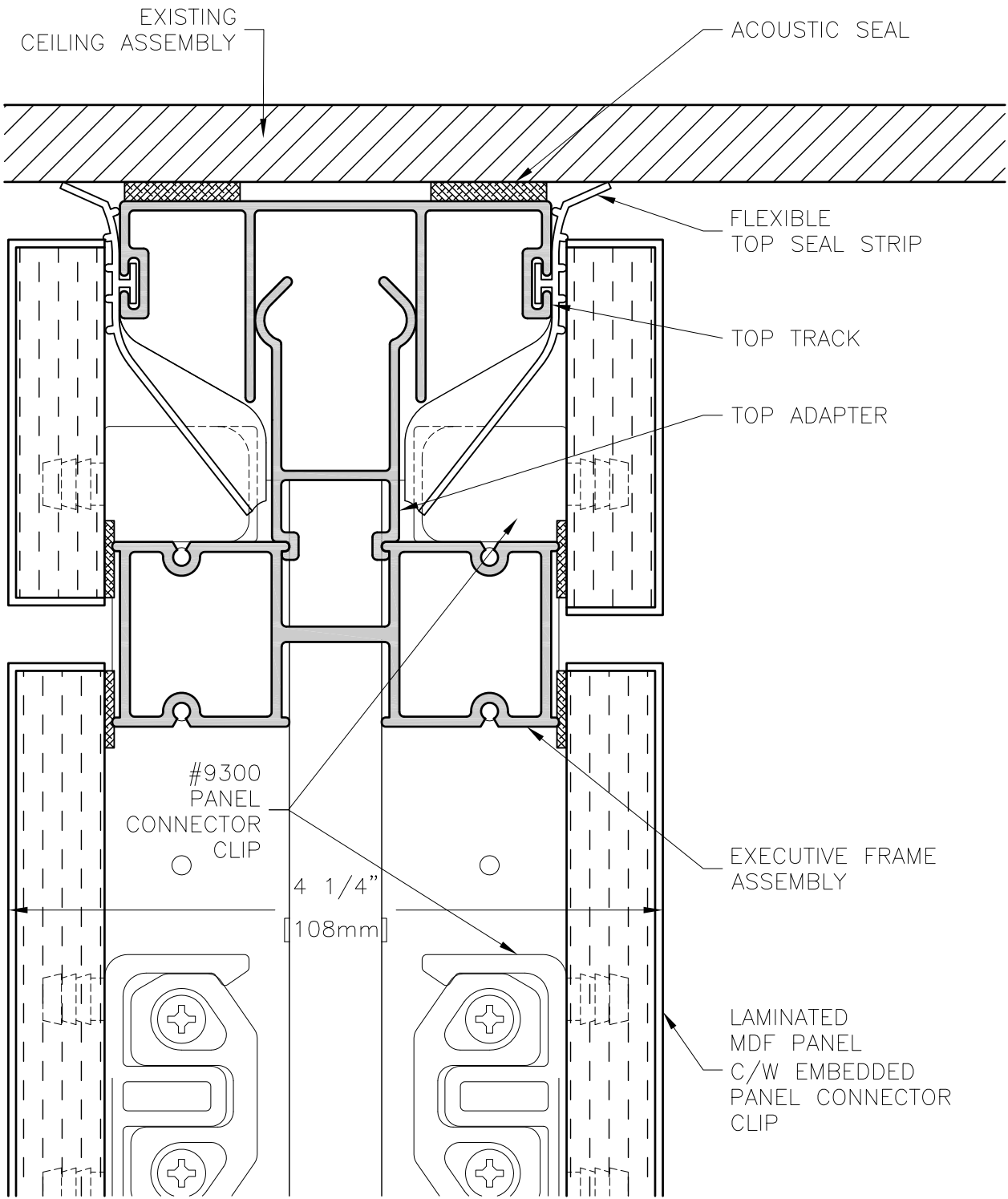

**PARTITION
SYSTEMS**

SOLID PANEL
AT CEILING
(STANDARD)

DWG:

E2.1.1

FILE: E2-1-1.DWG

SCALE: 1 : 1

DATE: NOV 2008

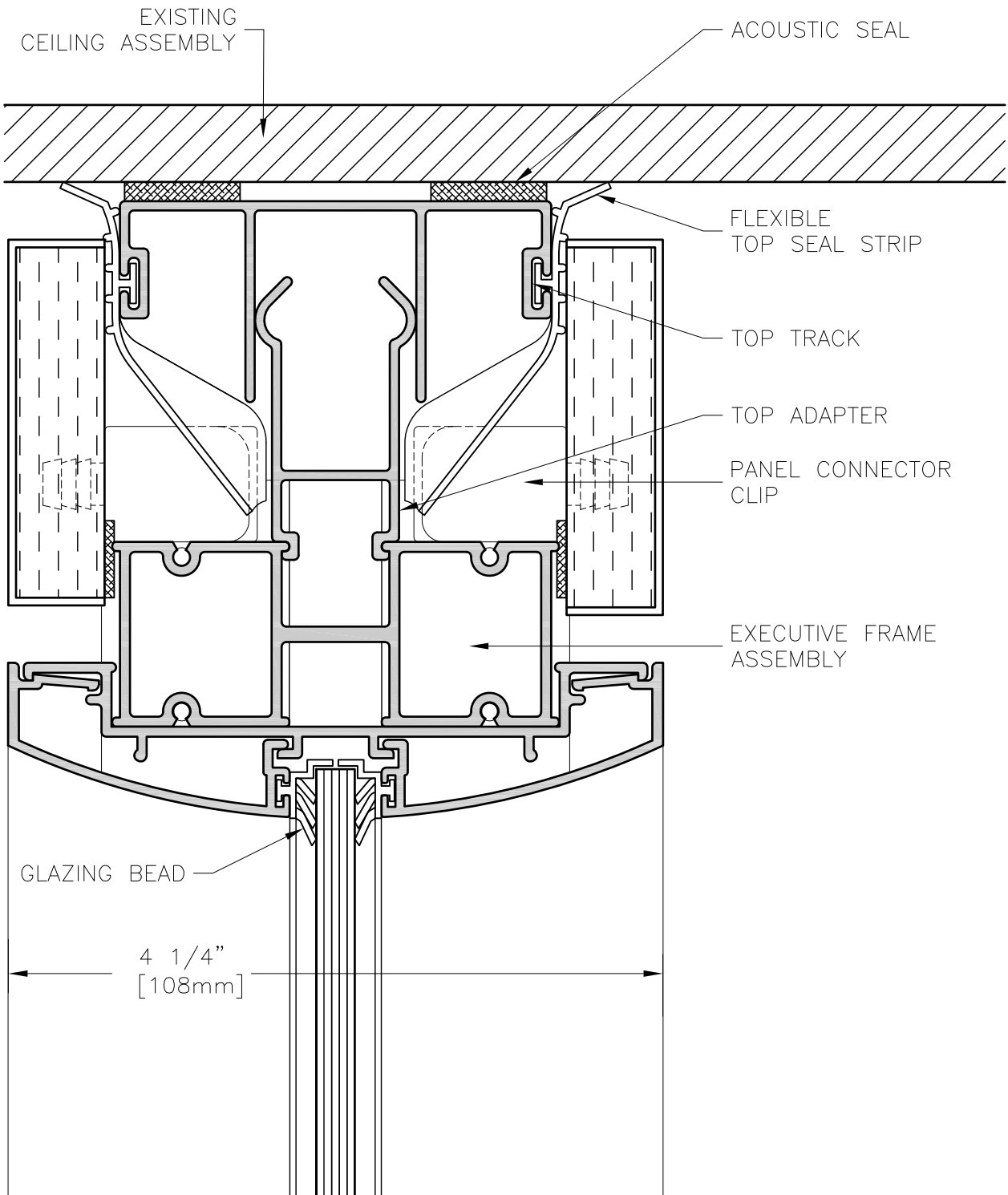

GLASS PANEL
AT CEILING
(STANDARD)

DWG:

E2.1.2

FILE: E2-1-2.DWG

SCALE: 1 : 1

DATE: NOV 2008

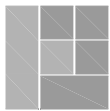
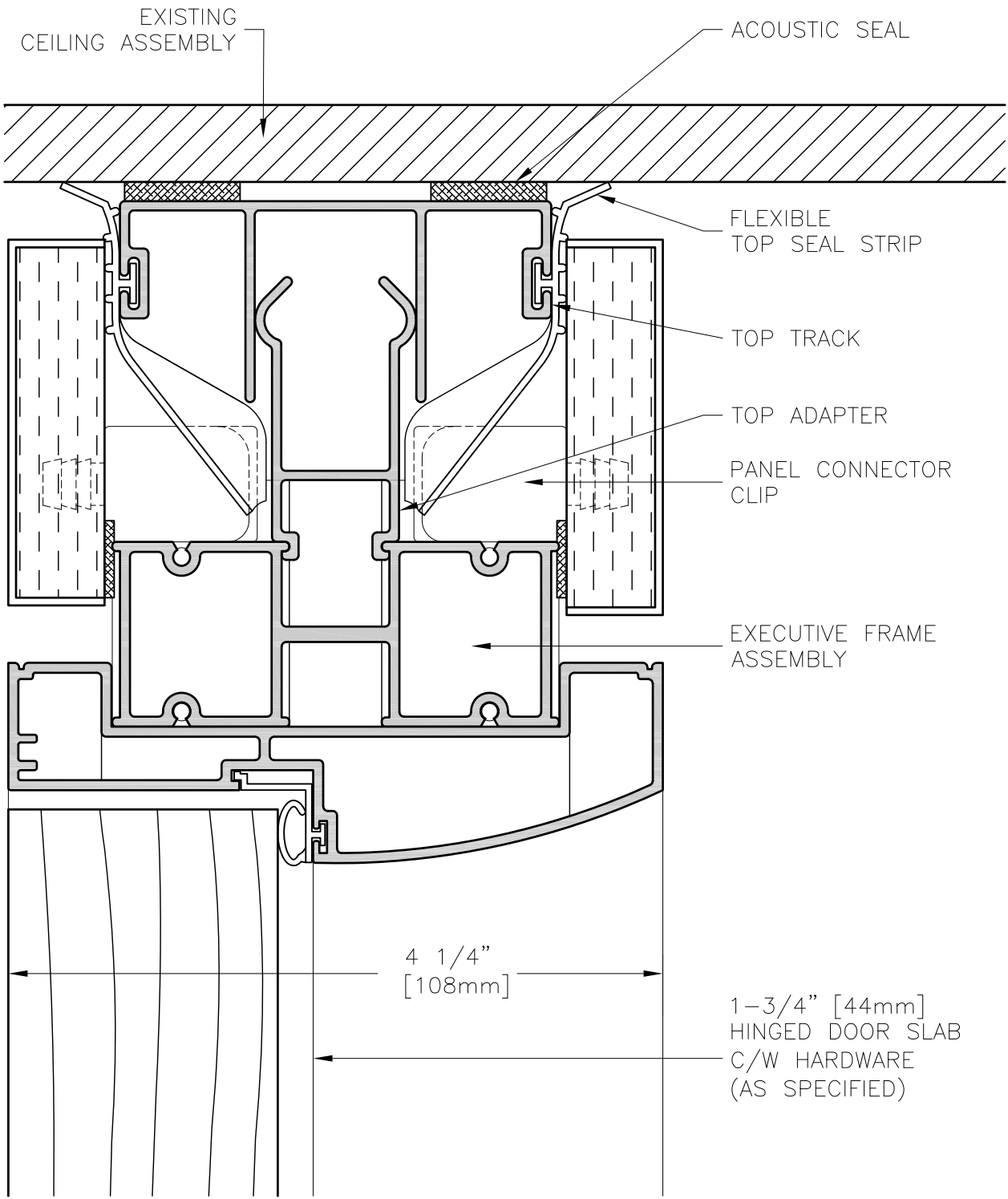

PARTITION SYSTEMS

HINGED DOOR FRAME
AT CEILING
(STANDARD)

DWG:

E2.1.3

FILE: E2-1-3.DWG

SCALE: 1 : 1

DATE: NOV 2008

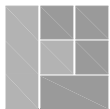
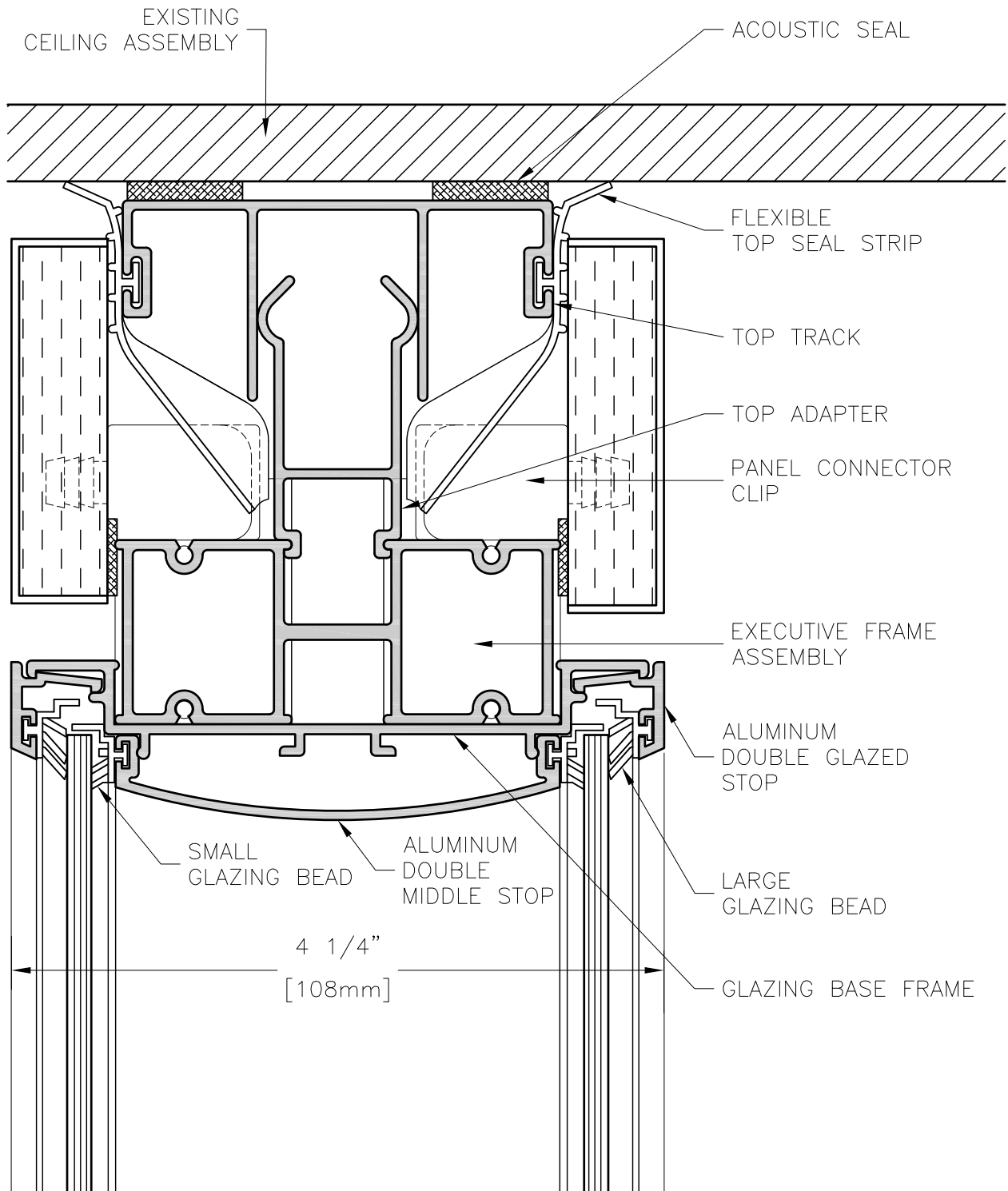

**PARTITION
SYSTEMS**

DOUBLE GLAZING PANEL
AT CEILING
(STANDARD)

DWG:

E2.1.4

FILE: E2-1-4.DWG

SCALE: 1 : 1

DATE: NOV 2008

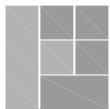
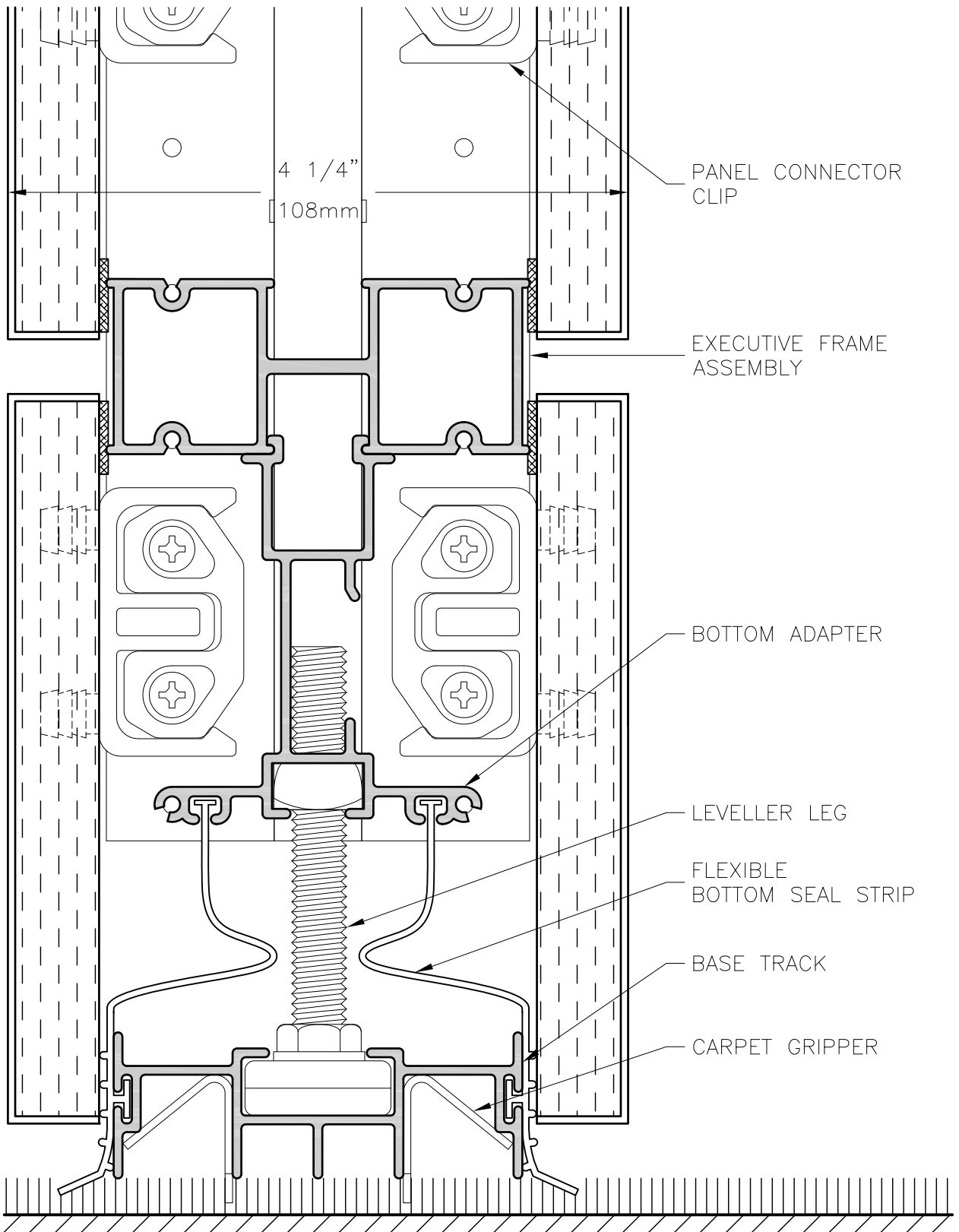

**PARTITION
SYSTEMS**

SOLID PANEL
AT FLOOR
(STANDARD)

DWG:

E3.1.1

FILE: E3-1-1.DWG

SCALE: 1 : 1

DATE: NOV 2008

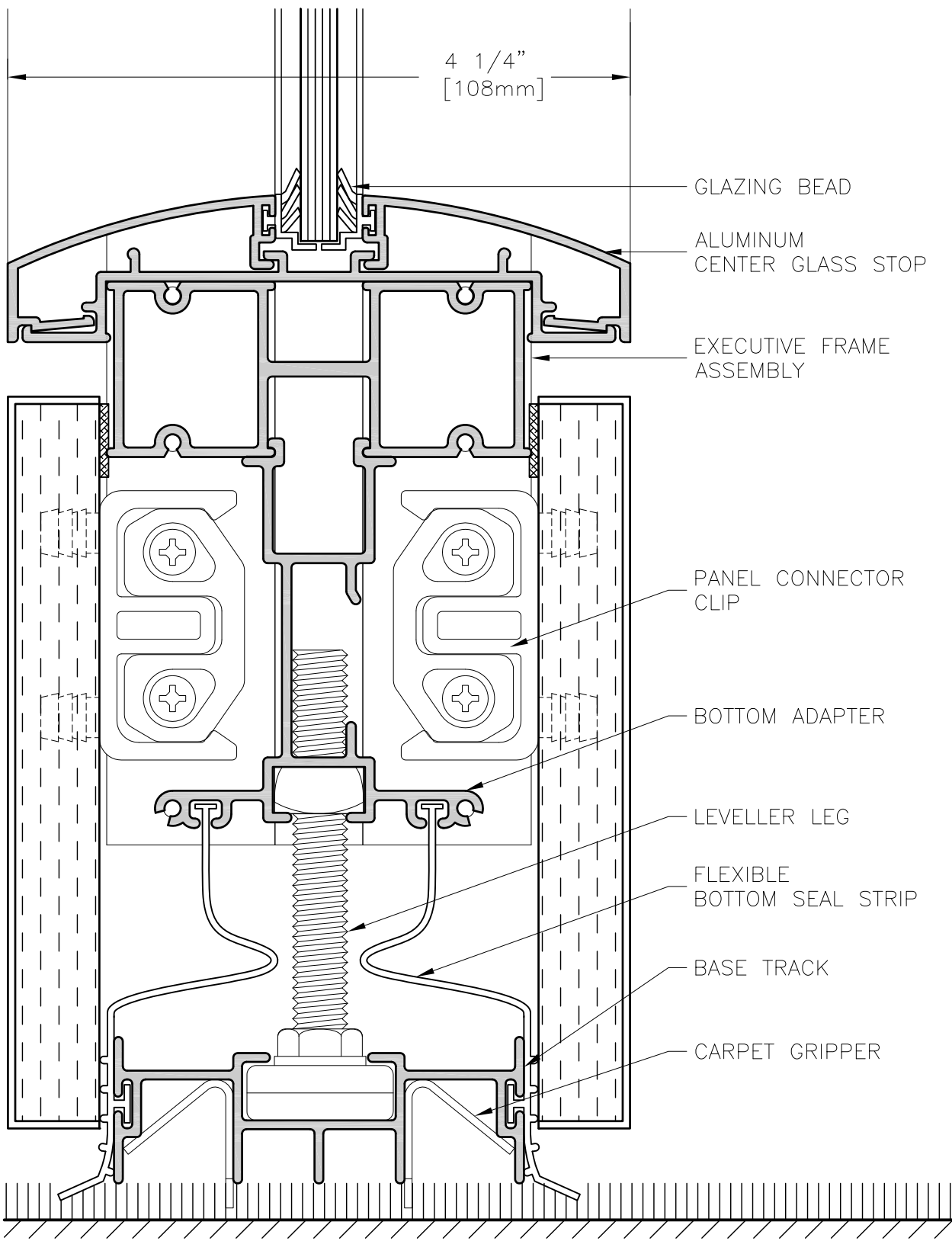

4 1/4"
[108mm]

GLAZING BEAD
ALUMINUM
CENTER GLASS STOP
EXECUTIVE FRAME
ASSEMBLY

PANEL CONNECTOR
CLIP
BOTTOM ADAPTER
LEVELLER LEG
FLEXIBLE
BOTTOM SEAL STRIP
BASE TRACK
CARPET GRIPPER

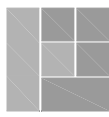

**PARTITION
SYSTEMS**

GLASS PANEL
AT FLOOR
(STANDARD)

DWG:
E3.1.2

FILE: E3-1-2.DWG

SCALE: 1 : 1

DATE: NOV 2008

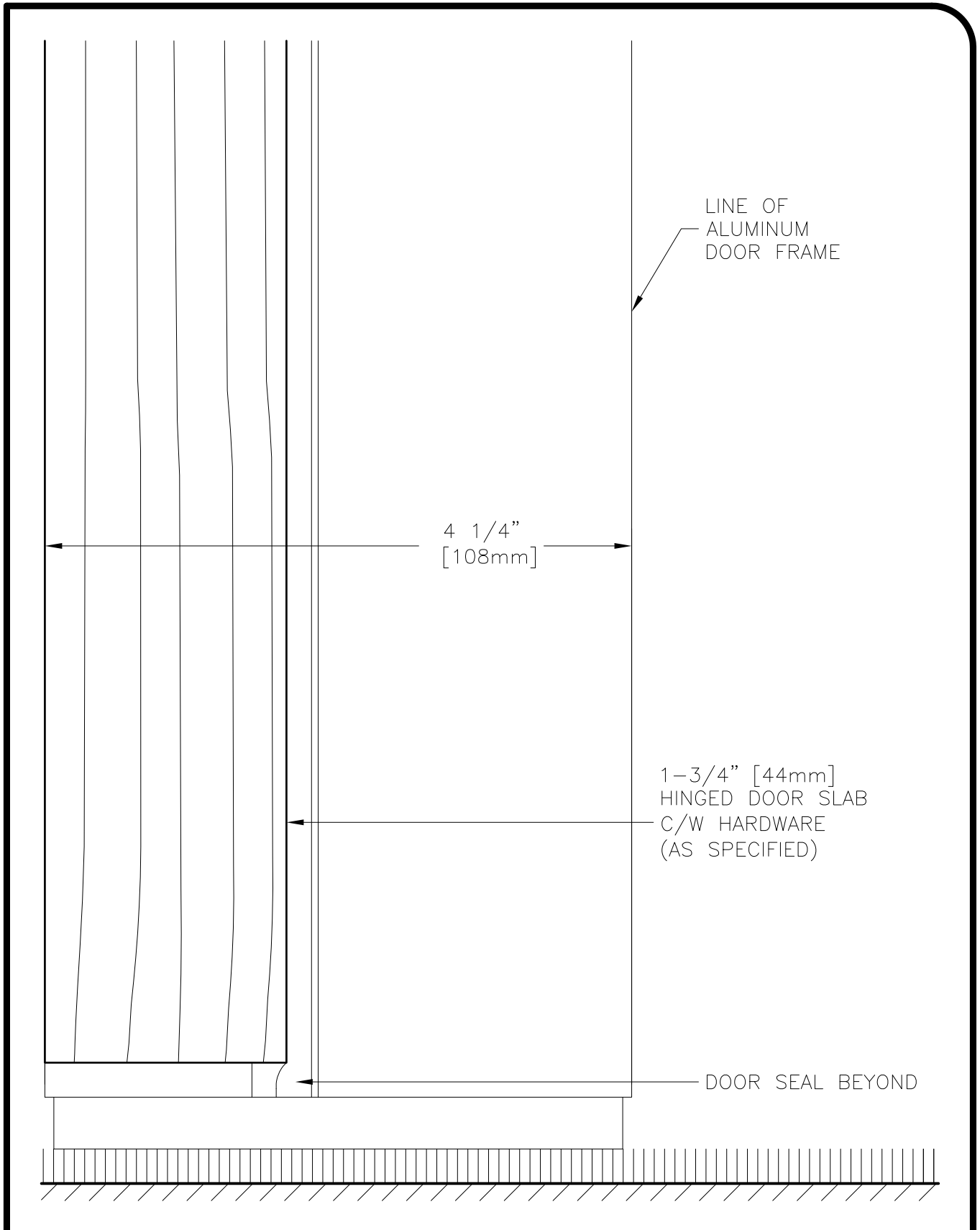

LINE OF
ALUMINUM
DOOR FRAME

4 1/4"
[108mm]

1-3/4" [44mm]
HINGED DOOR SLAB
C/W HARDWARE
(AS SPECIFIED)

DOOR SEAL BEYOND

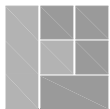

**PARTITION
SYSTEMS**

HINGED DOOR FRAME
AT FLOOR
(STANDARD)

DWG:

E3.1.3

FILE: E3-1-3.DWG

SCALE: 1 : 1

DATE: NOV 2008

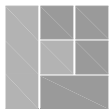
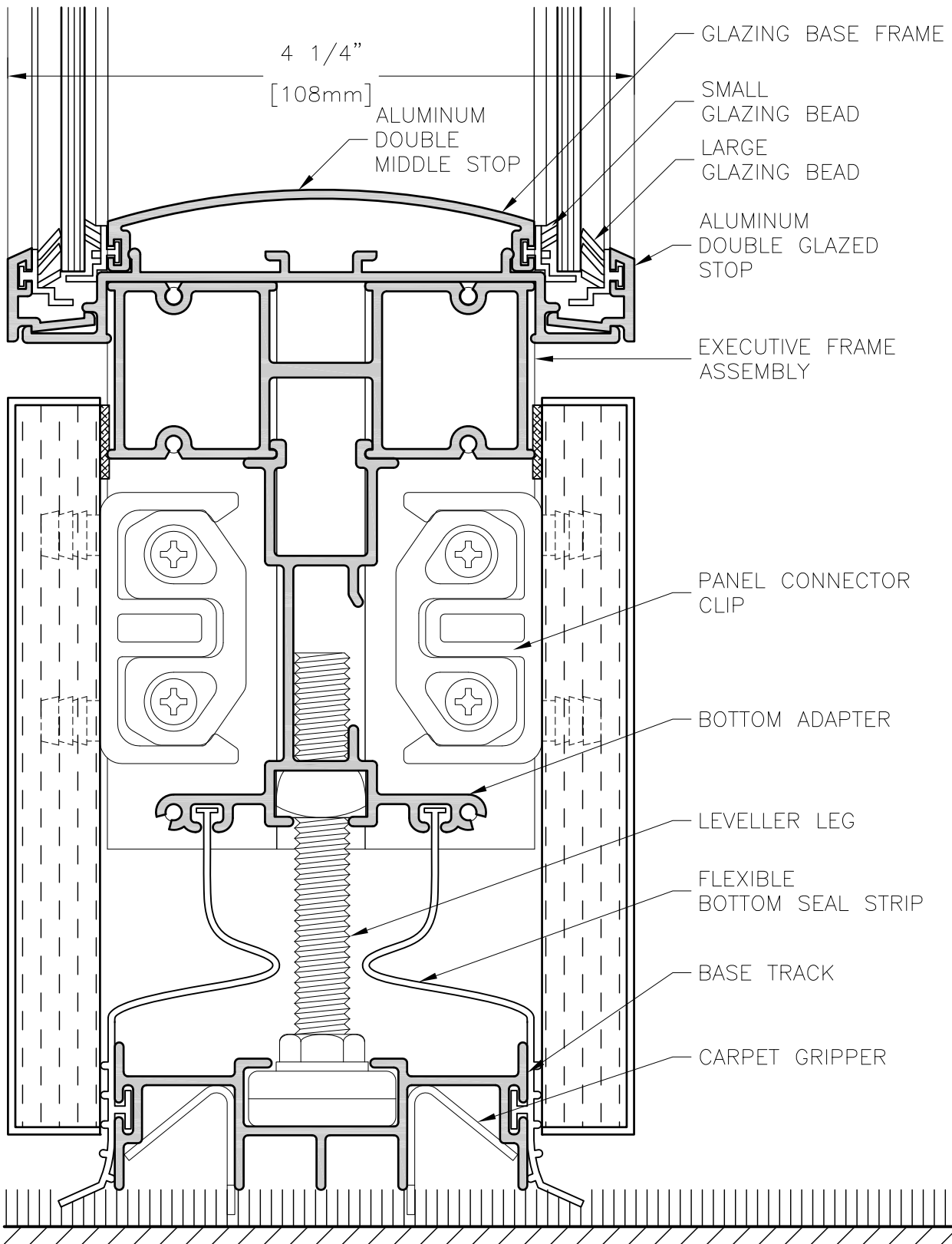

PARTITION SYSTEMS

DOUBLE GLAZED PANEL
AT FLOOR
(STANDARD)

DWG:

E3.1.4

FILE: E3-1-4.DWG

SCALE: 1 : 1

DATE: NOV 2008

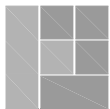
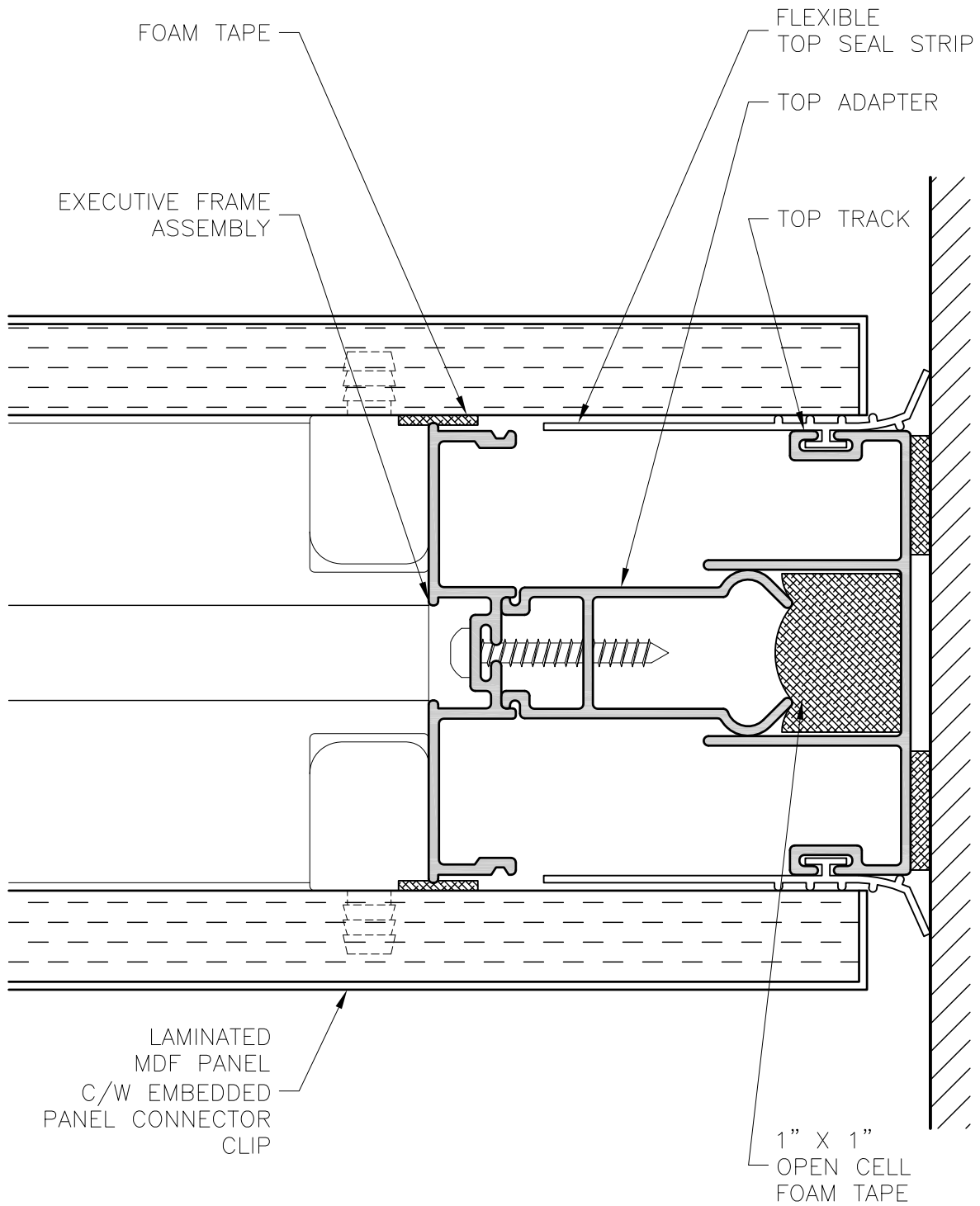

**PARTITION
SYSTEMS**

SOLID FRAME
WALL START DETAIL
(STANDARD)

DWG:

E4.1.1

FILE: E4-1-1.DWG

SCALE: 1 : 1

DATE: NOV 2008

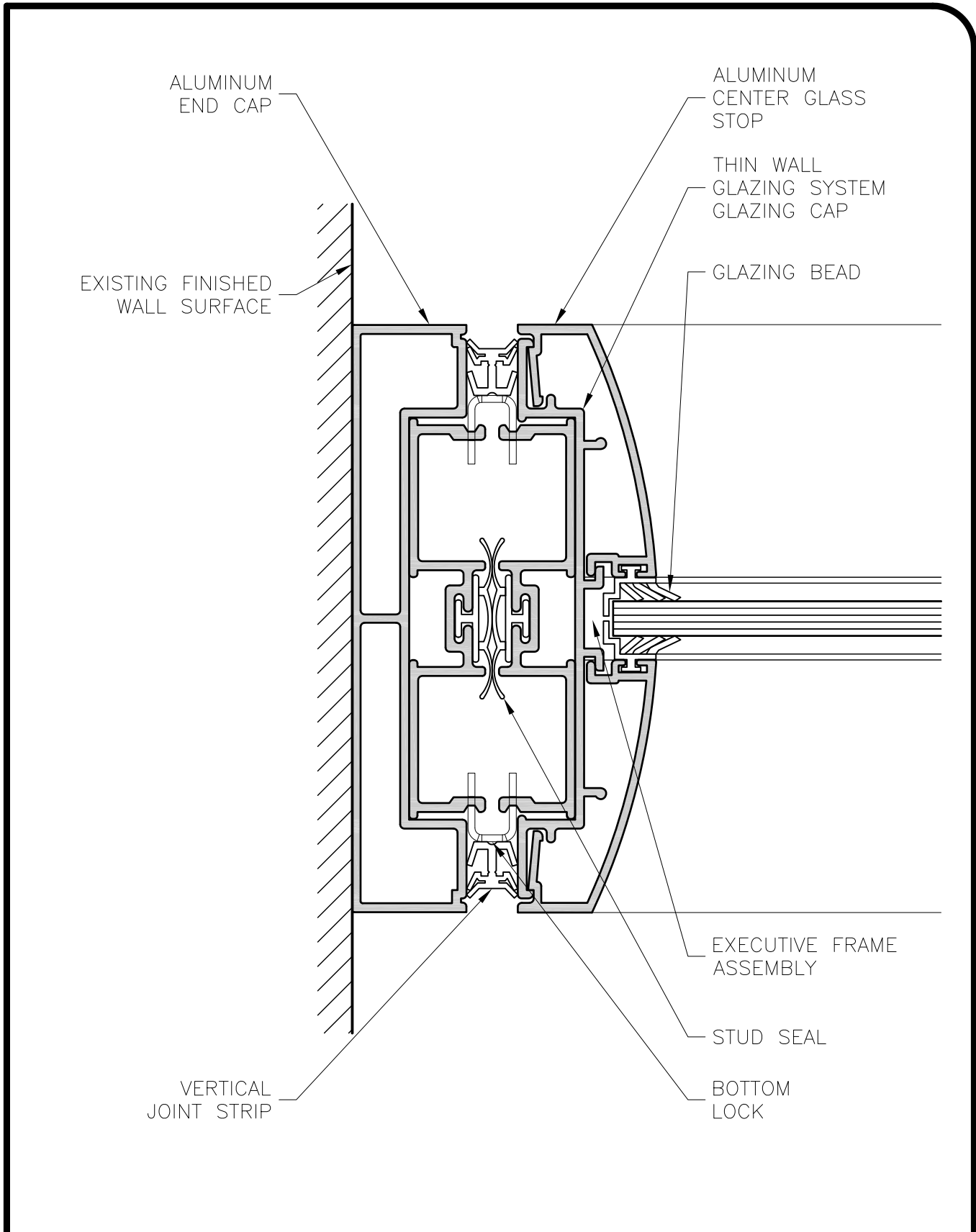

END CAP
GLASS PANEL DETAIL
(STANDARD)

DWG:
E4.1.2

FILE: E4-1-2.DWG

SCALE: 1 : 1

DATE: NOV 2008

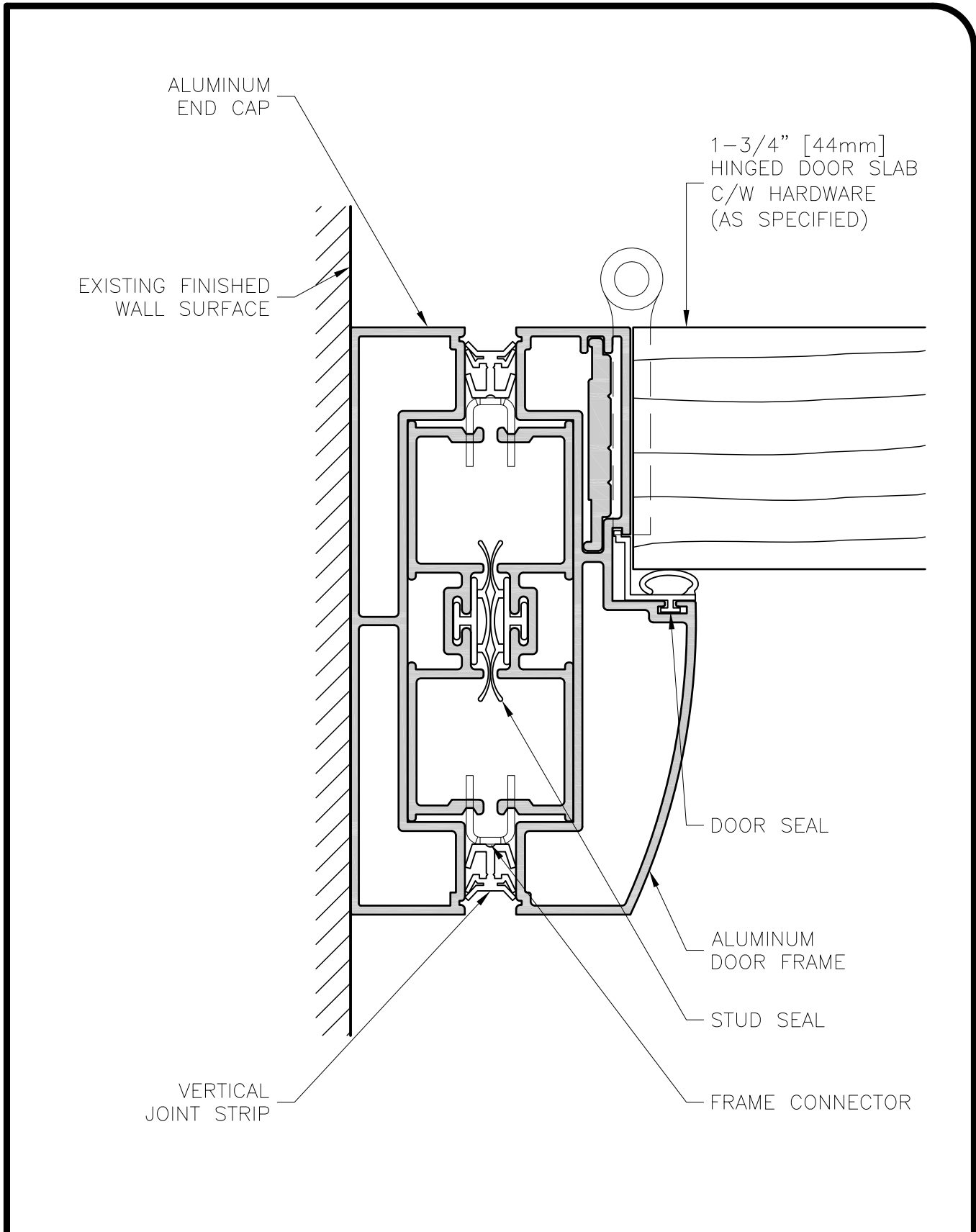

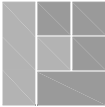
 PARTITION SYSTEMS	END CAP DOOR FRAME DETAIL (STANDARD)	DWG: E4.1.3
FILE: E4-1-3.DWG	SCALE: 1 : 1	DATE: NOV 2008

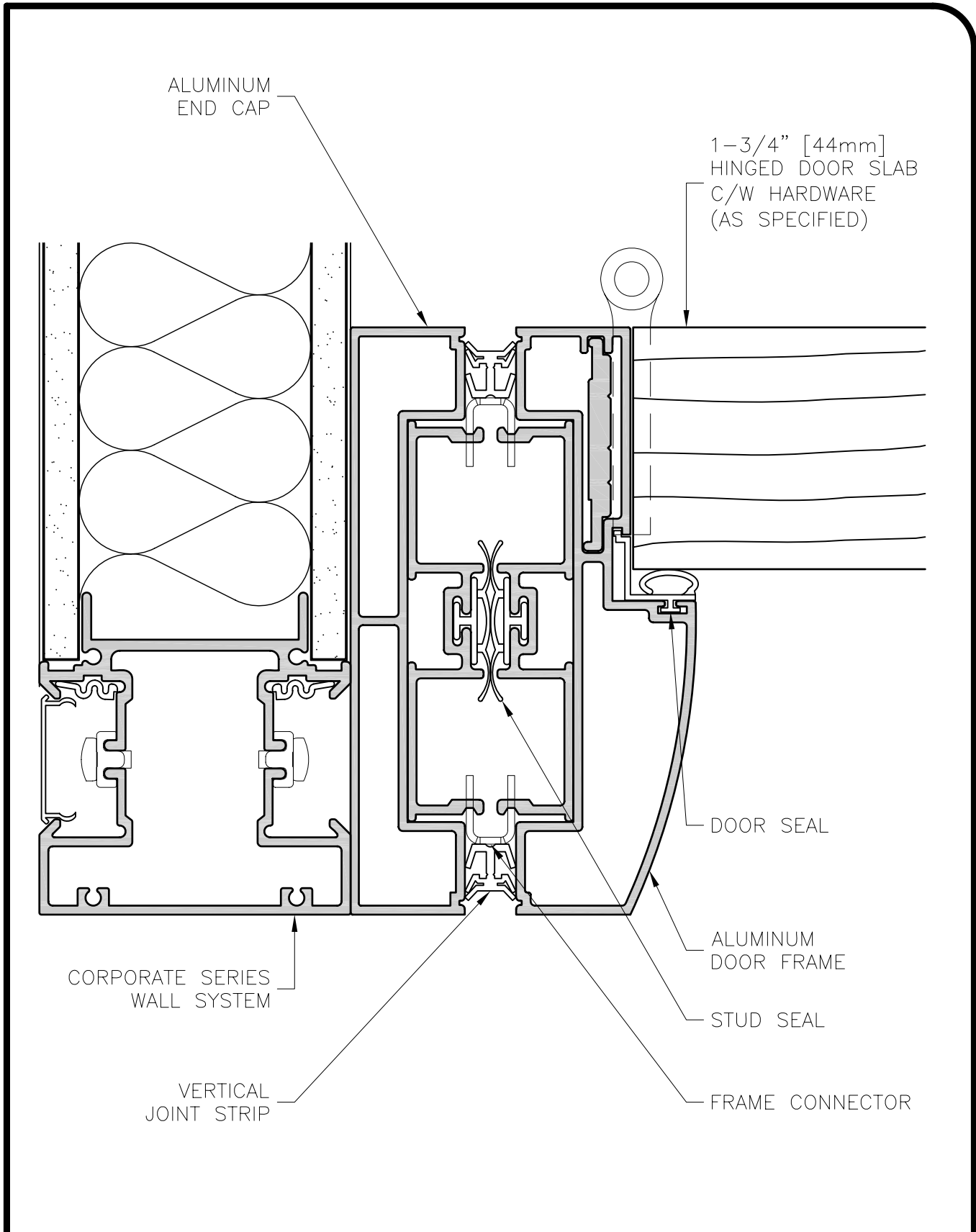

END CAP/DOOR FRAME
DETAIL AT CORPORATE
(STANDARD)

DWG:
E4.1.4

FILE: E4-1-4.DWG

SCALE: 1 : 1

DATE: NOV 2008

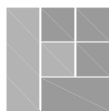
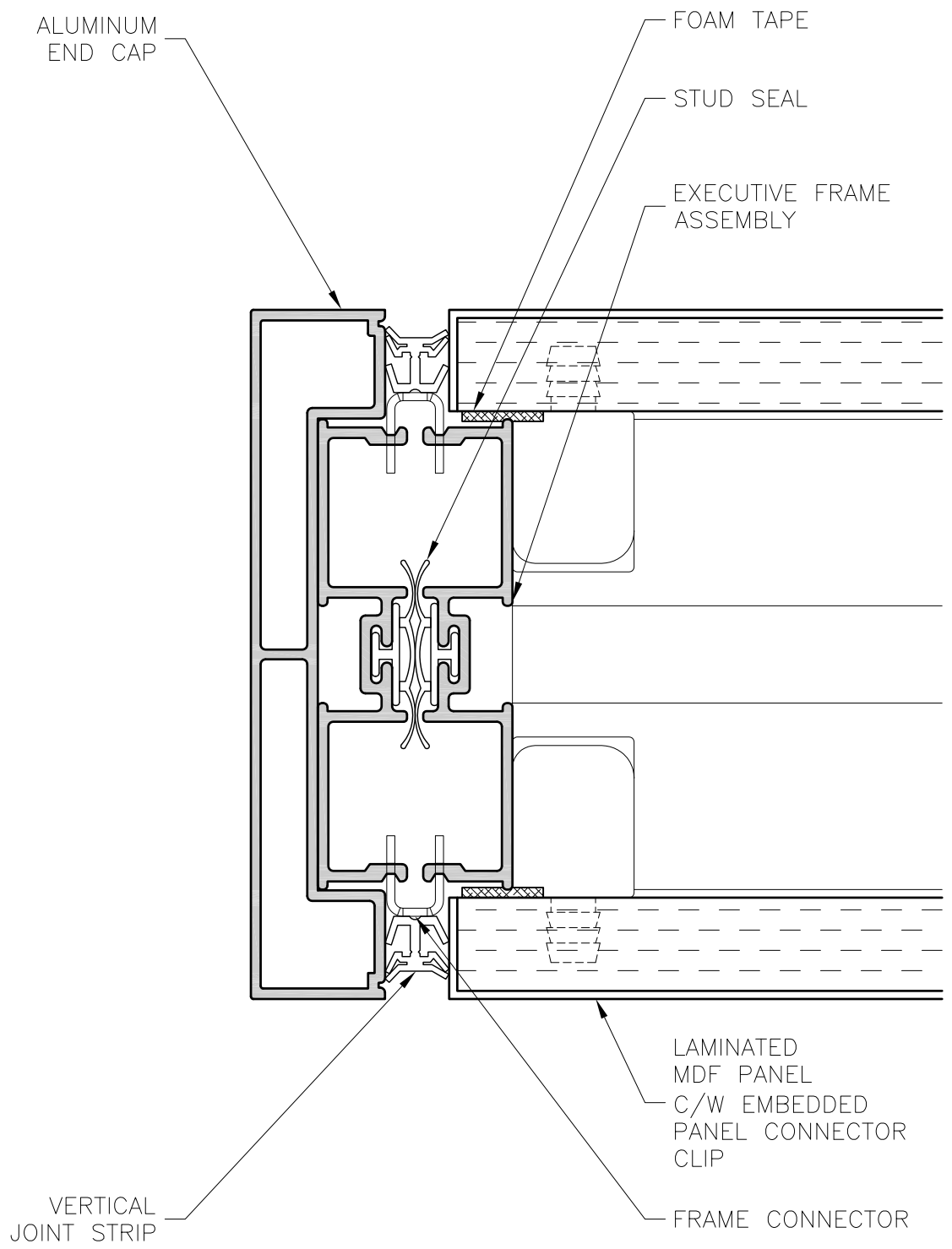

**PARTITION
SYSTEMS**

ALUMINUM END CAP
SOLID PANEL
TERMINATION

DWG:

E4.2.1

FILE: E4-2-1.DWG

SCALE: 1 : 1

DATE: NOV 2008

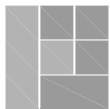
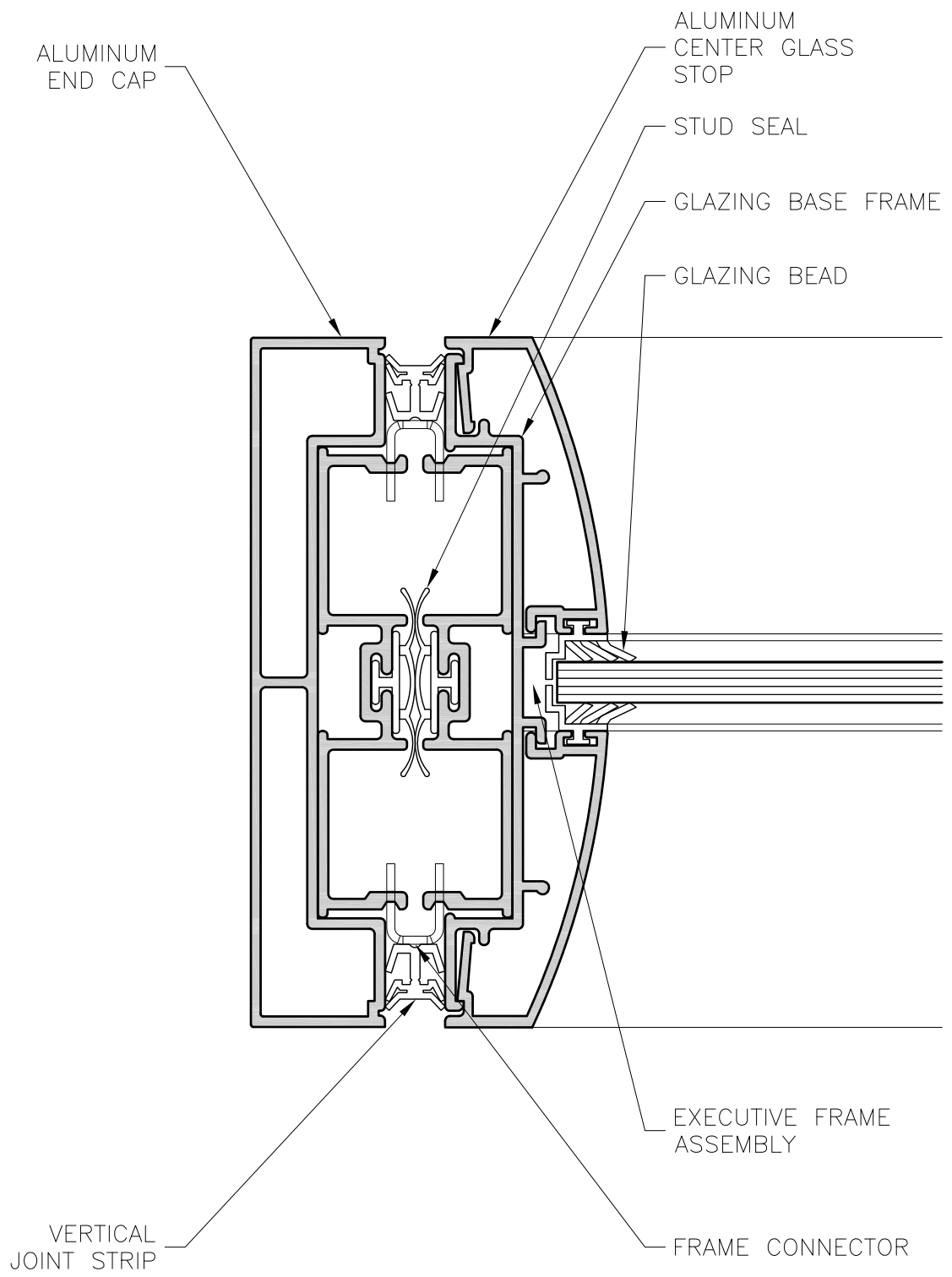

**PARTITION
SYSTEMS**

ALUMINUM END CAP
GLASS PANEL
TERMINATION

DWG:

E4.2.2

FILE: E4-2-2.DWG

SCALE: 1 : 1

DATE: NOV 2008

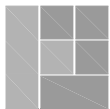
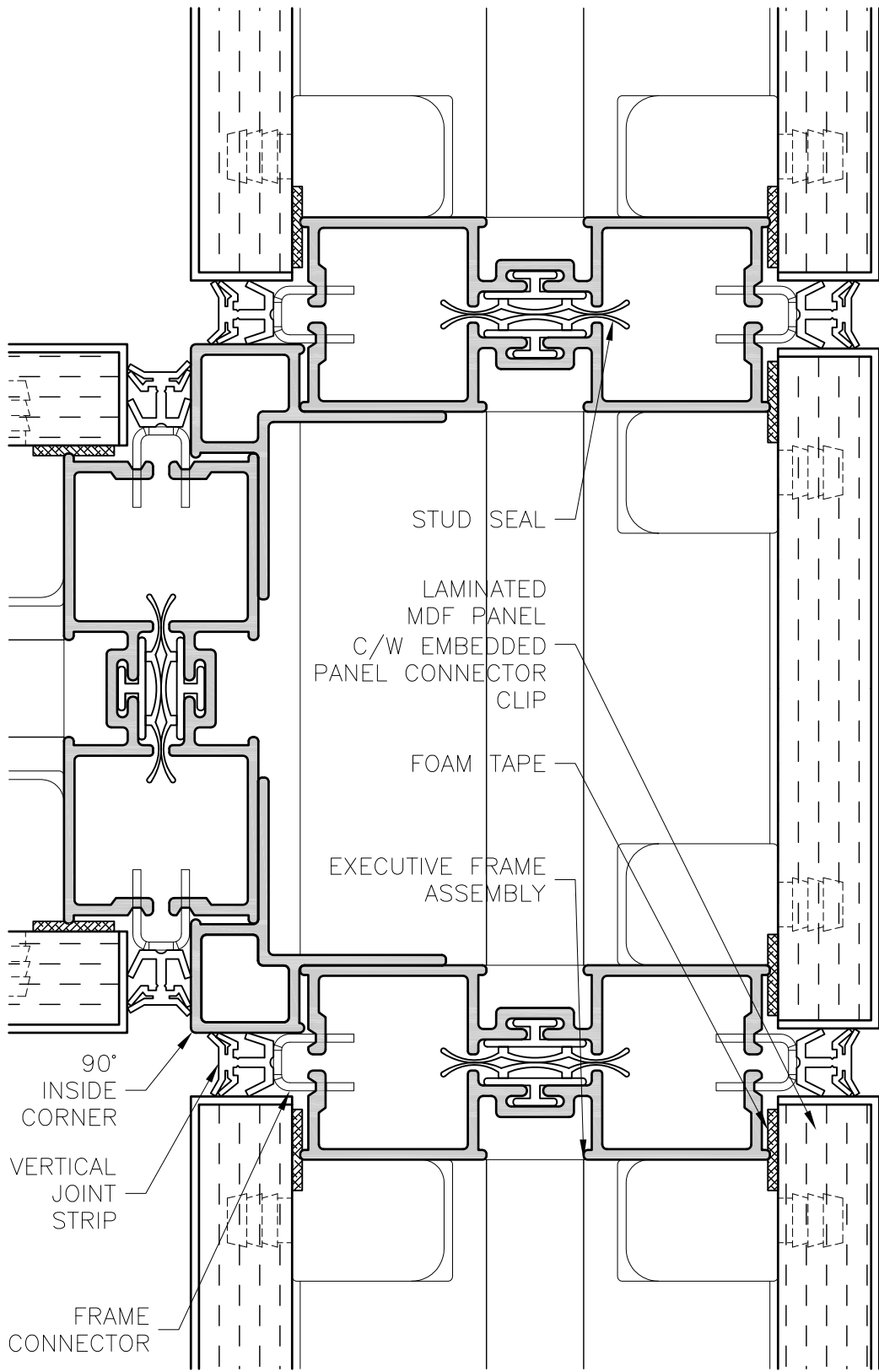

**PARTITION
SYSTEMS**

3-WAY POST
SOLID/SOLID/SOLID
(STANDARD)

DWG:

E5.1.1

FILE: E5-1-1.DWG

SCALE: 1 : 1

DATE: NOV 2008

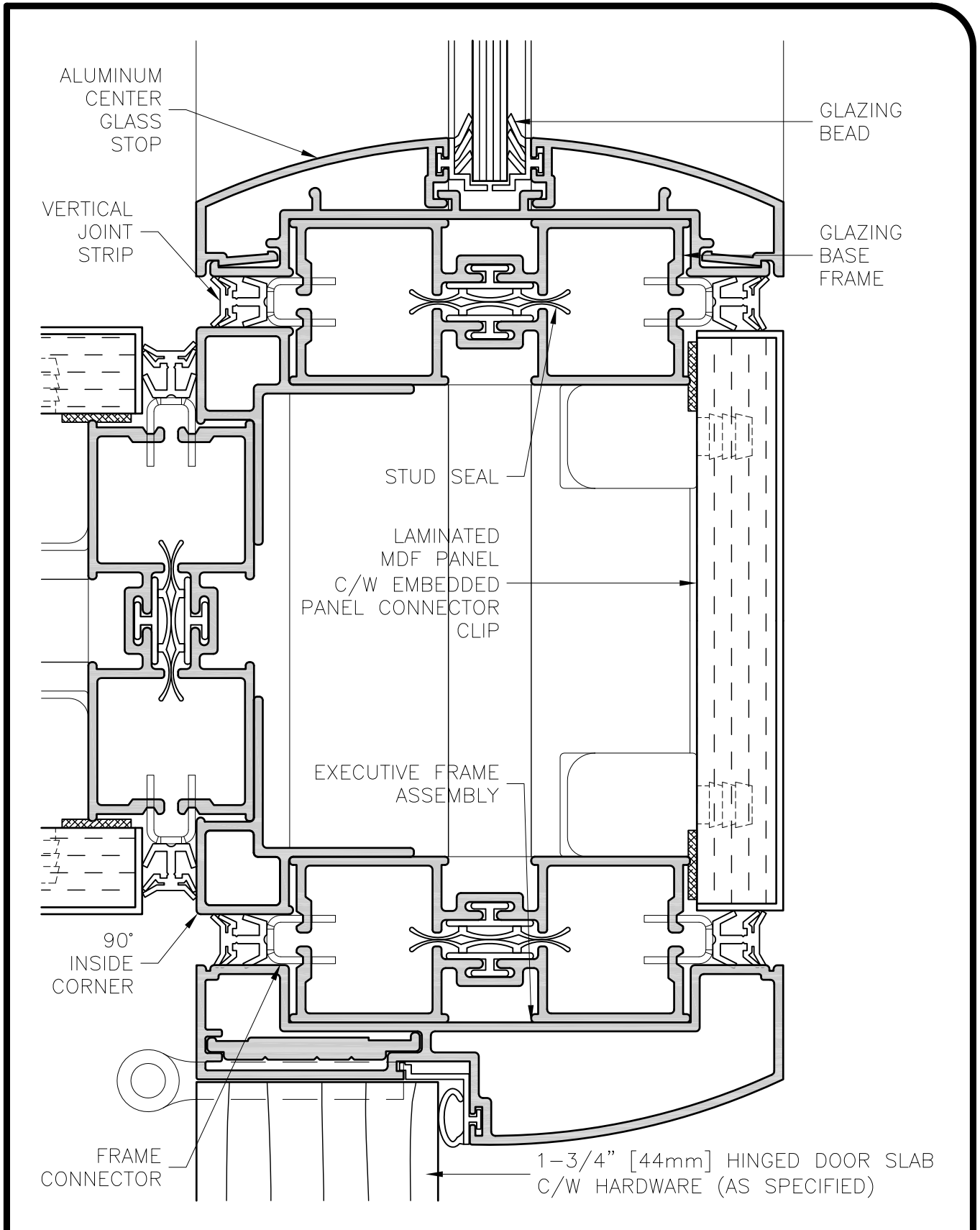

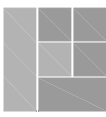
 PARTITION SYSTEMS	3-WAY POST DOOR/GLASS/SOLID (STANDARD)	DWG: E5.1.2
FILE: E5-1-2.DWG	SCALE: 1 : 1	DATE: NOV 2008

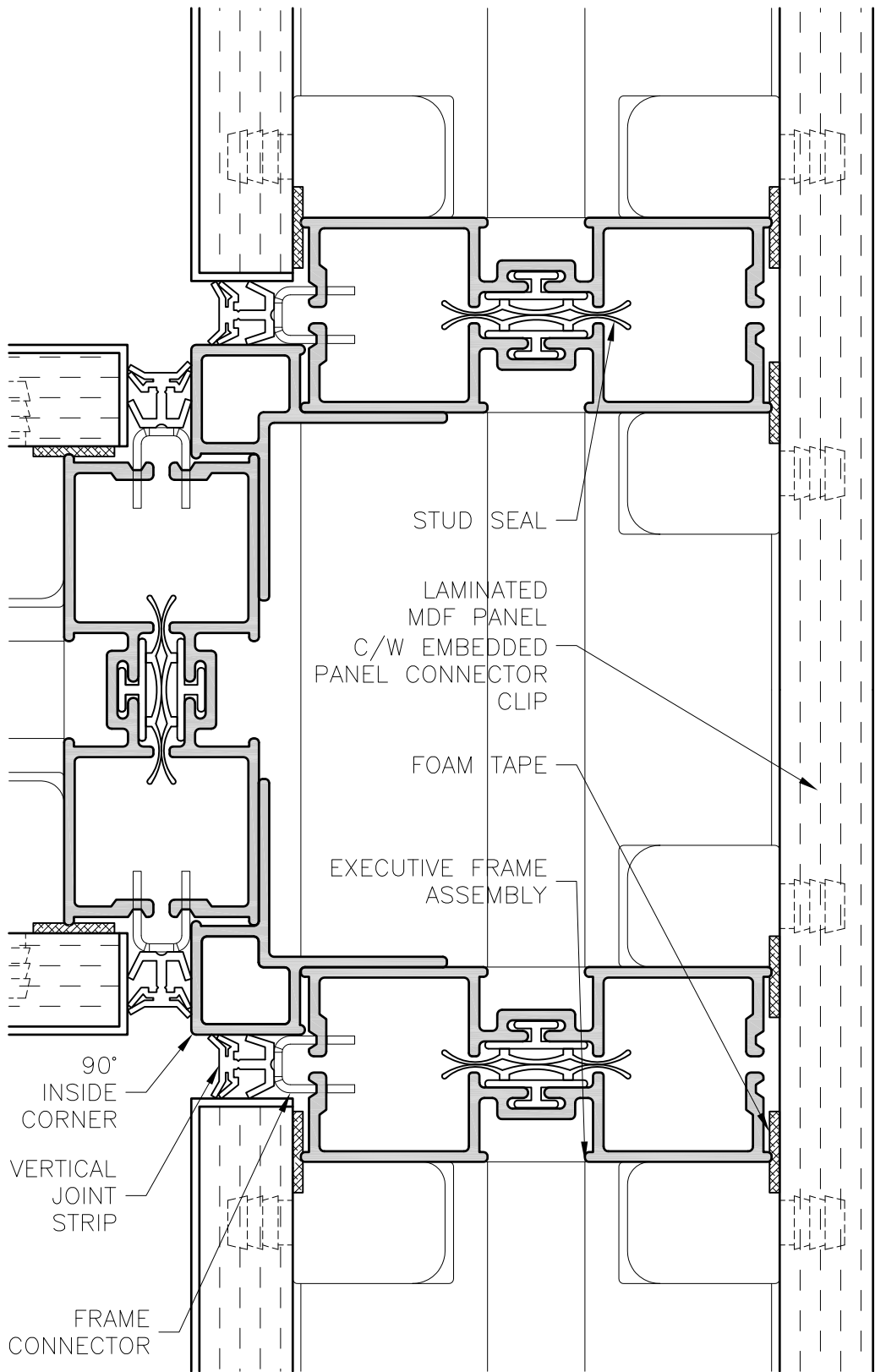

**PARTITION
SYSTEMS**

3-WAY POST
SOLID/SOLID/SOLID
(HIDDEN CONFIGURATION)

DWG:

E5.1.3

FILE: E5-1.DWG

SCALE: 1 : 1

DATE: JAN 2010

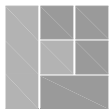
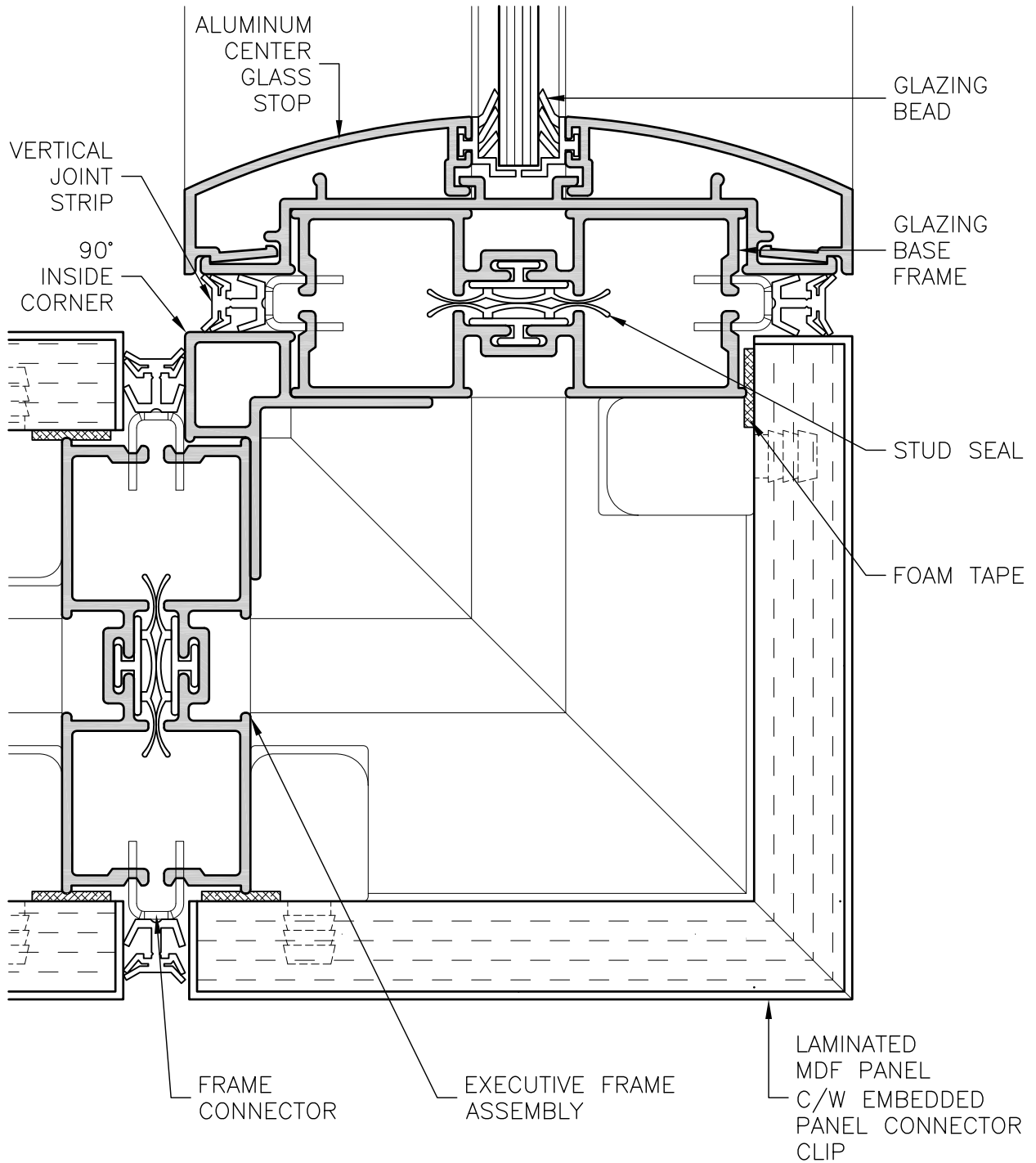

**PARTITION
SYSTEMS**

90° CORNER POST
SOLID PANEL
GLASS PANEL

DWG:

E5.2.1

FILE: E5-2-1.DWG

SCALE: 1 : 1

DATE: NOV 2008

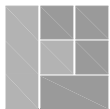
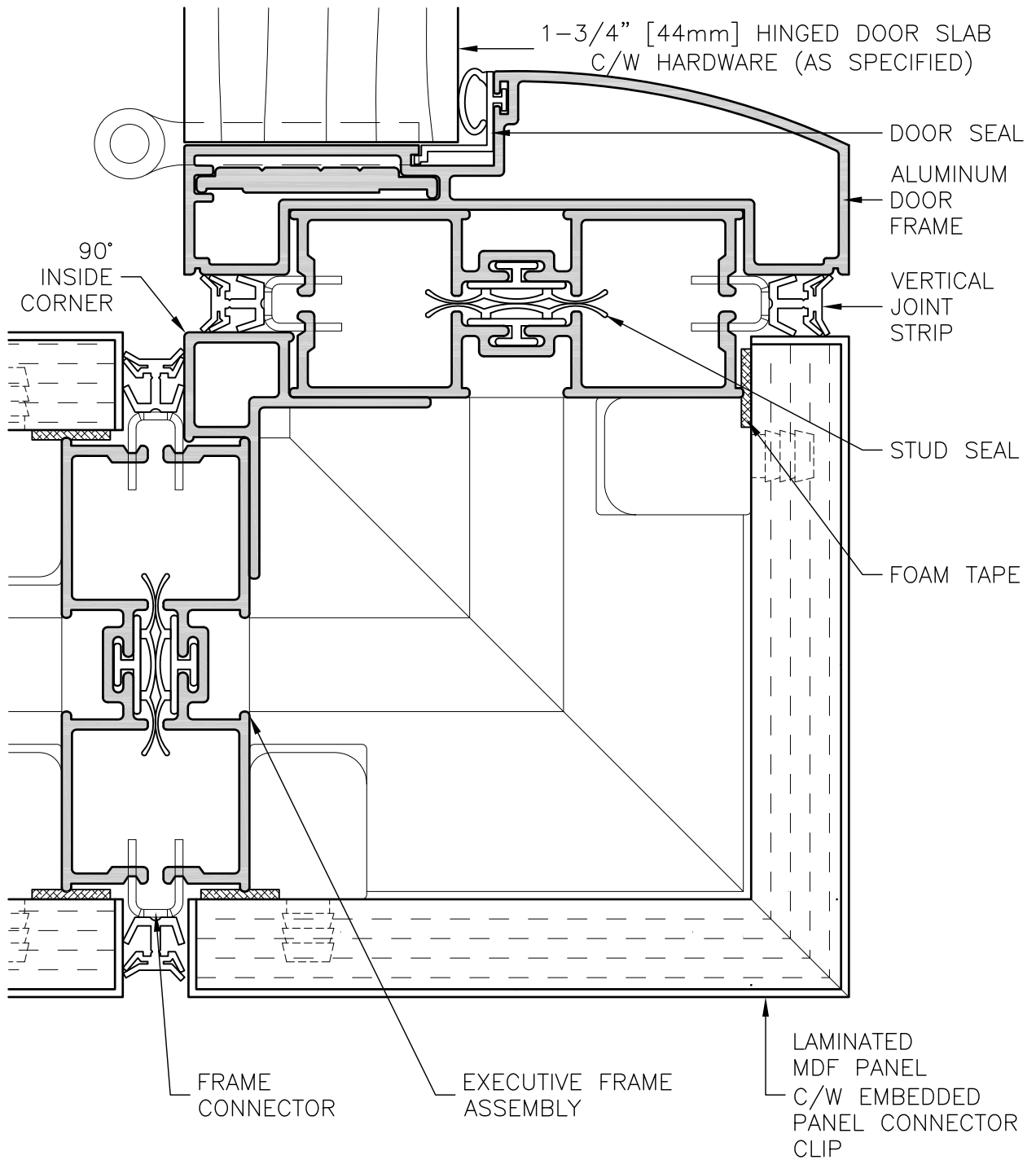

**PARTITION
SYSTEMS**

90° CORNER POST
SOLID PANEL
HINGED DOOR FRAME

DWG:

E5.2.2

FILE: E5-2-2.DWG

SCALE: 1 : 1

DATE: NOV 2008

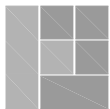
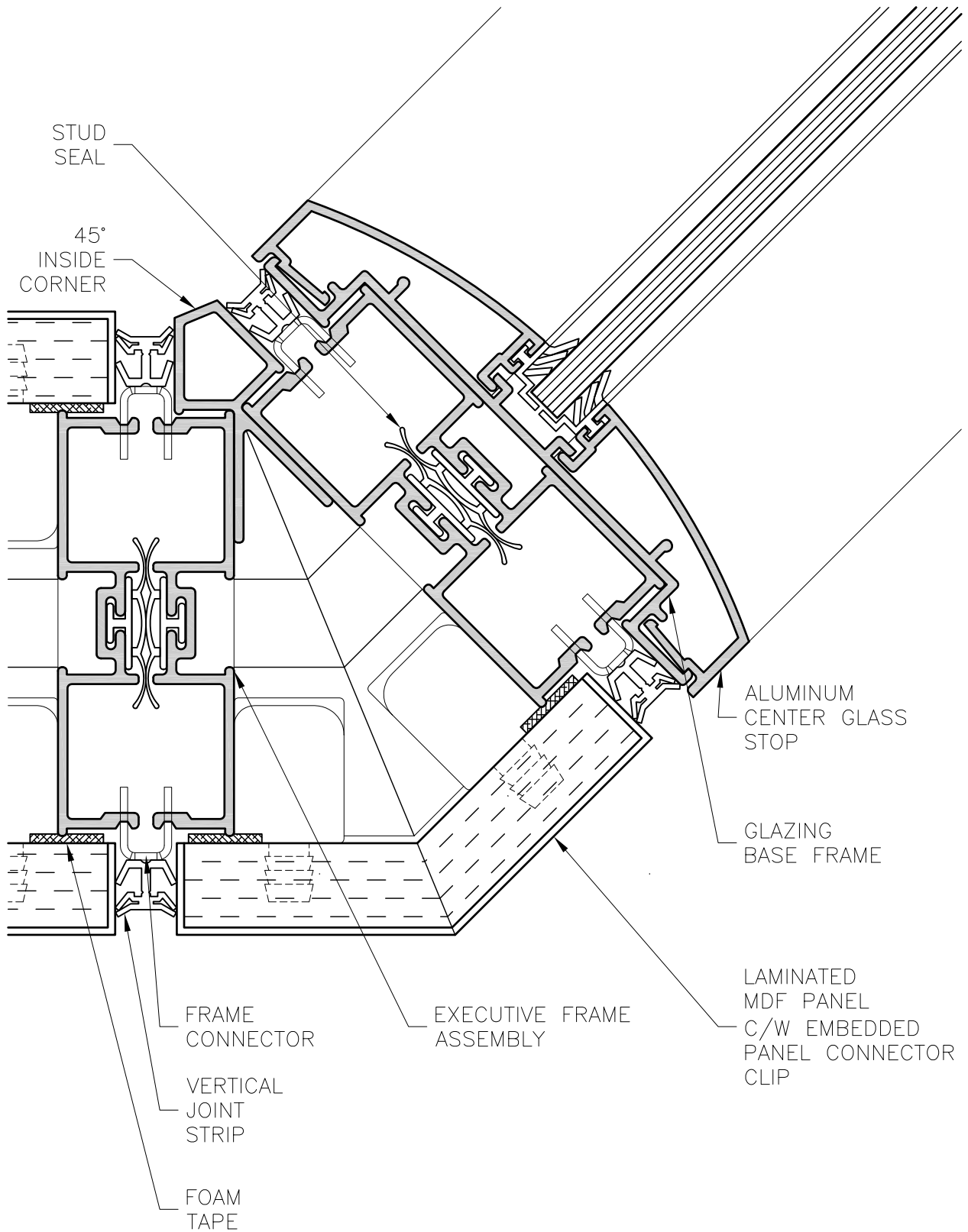

**PARTITION
SYSTEMS**

135° CORNER POST
SOLID-GLOSS
(TYPICAL)

DWG:

E5.3.1

FILE: E5-3-1.DWG

SCALE: 1 : 1

DATE: NOV 2008

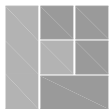
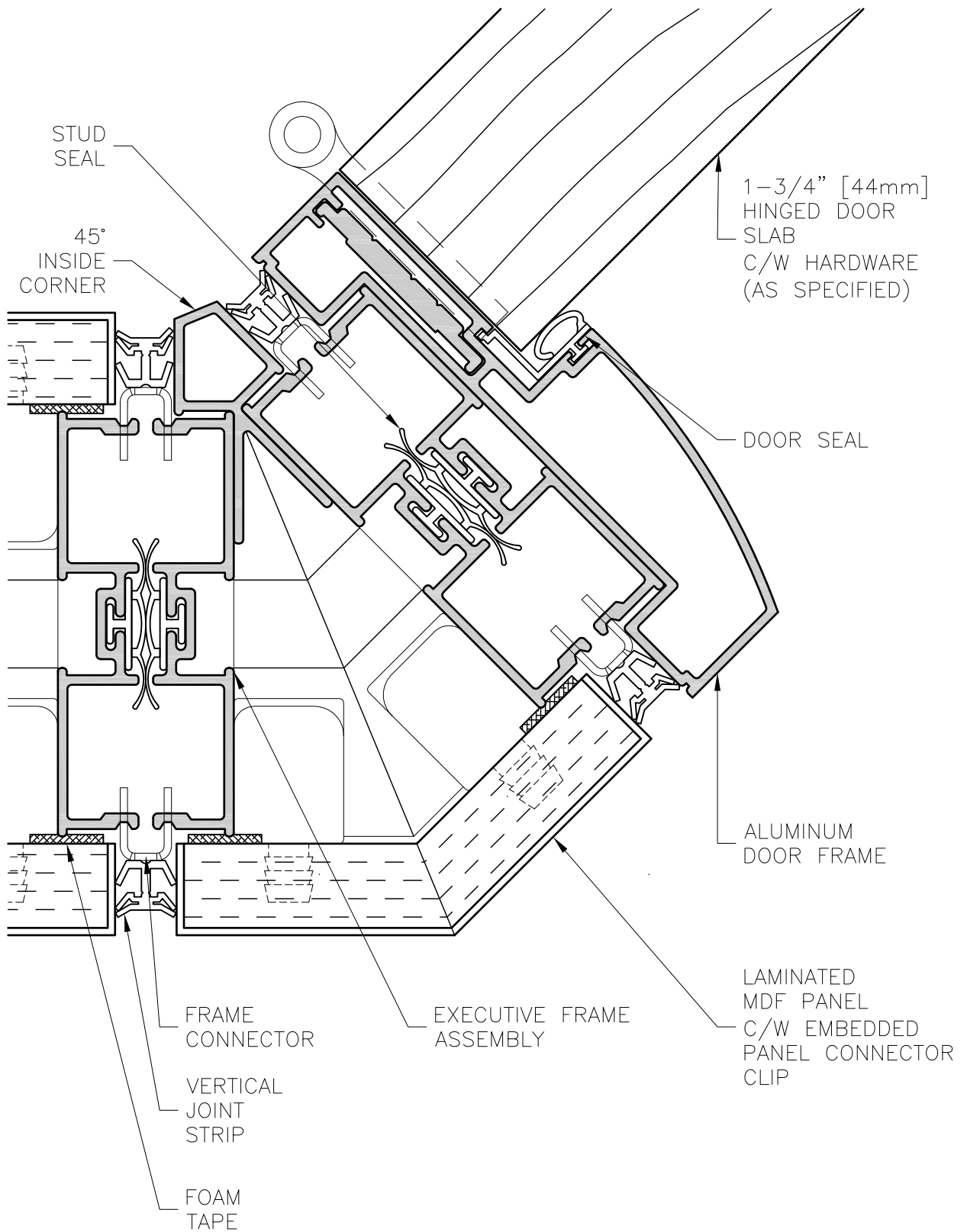

**PARTITION
SYSTEMS**

135° CORNER POST
SOLID-DOOR
(TYPICAL)

DWG:

E5.3.2

FILE: E5-3-2.DWG

SCALE: 1 : 1

DATE: NOV 2008

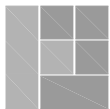
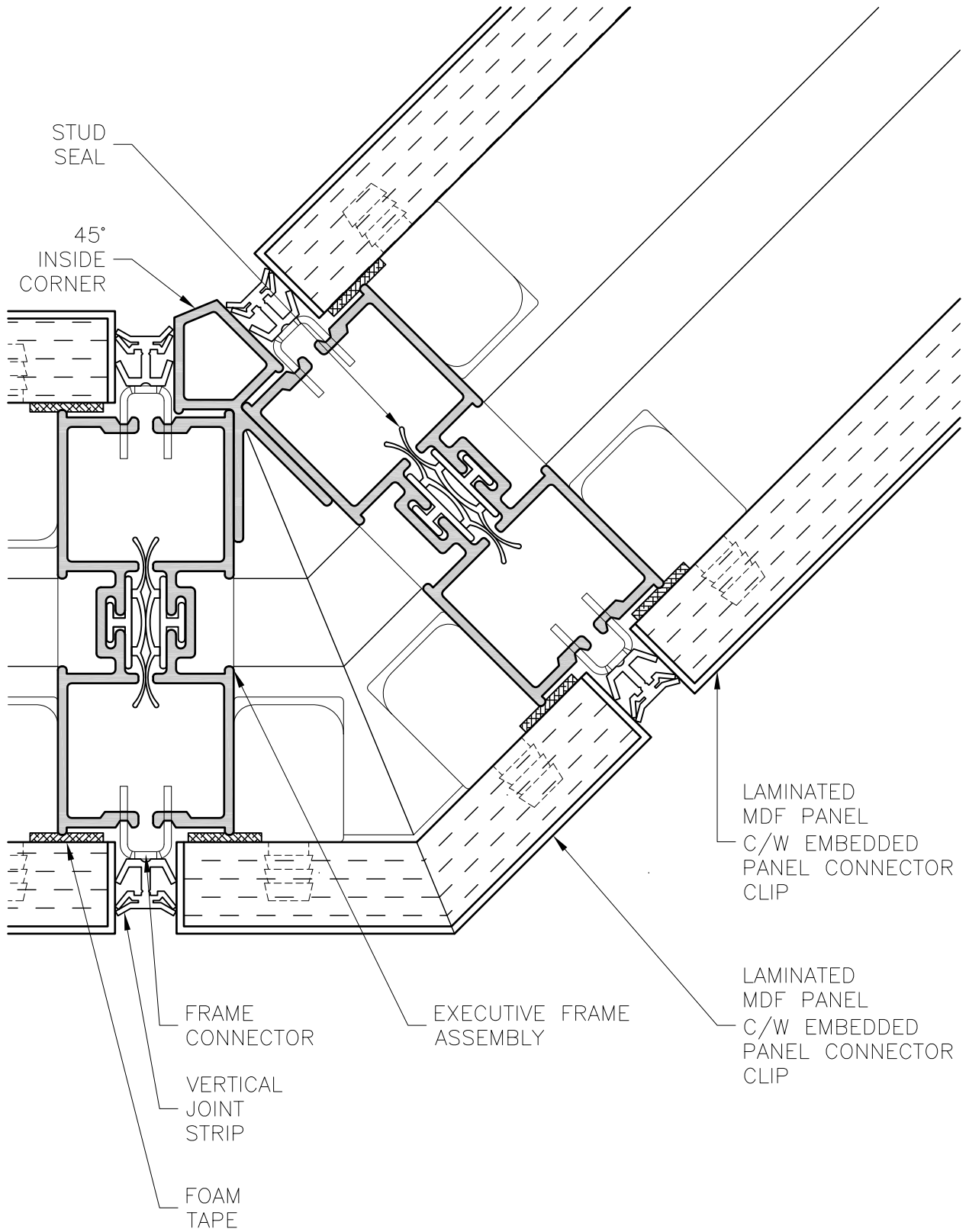

PARTITION SYSTEMS

135° CORNER POST
SOLID-SOLID
(TYPICAL)

DWG:

E5.3.3

FILE: E5-3-3.DWG

SCALE: 1 : 1

DATE: NOV 2008

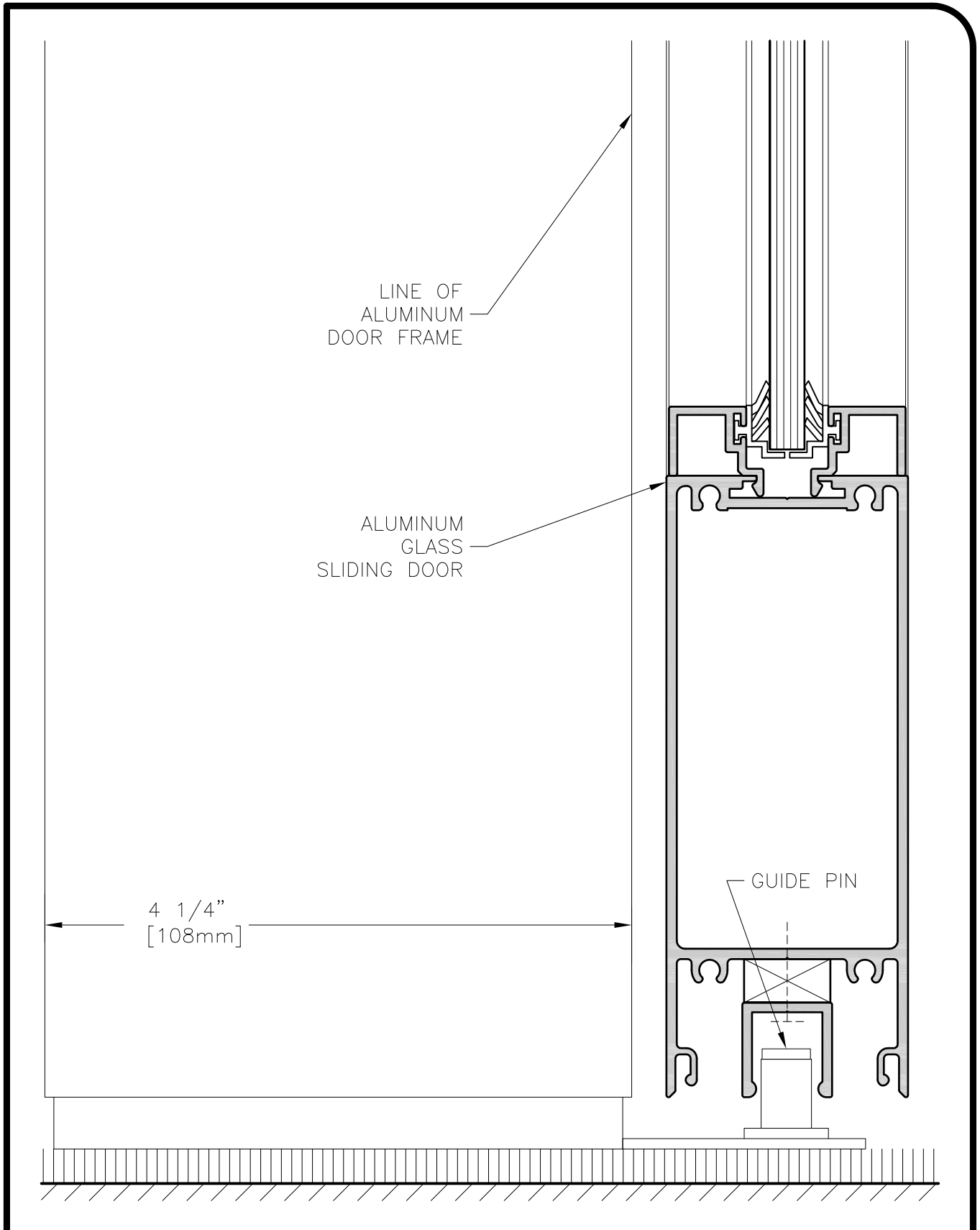

 PARTITION SYSTEMS	GLASS SLIDING DOOR ON FLAT DOOR FRAME AT FLOOR	DWG: E6.1.1
FILE: E6-1-1.DWG	SCALE: 1 : 1	DATE: NOV 2008

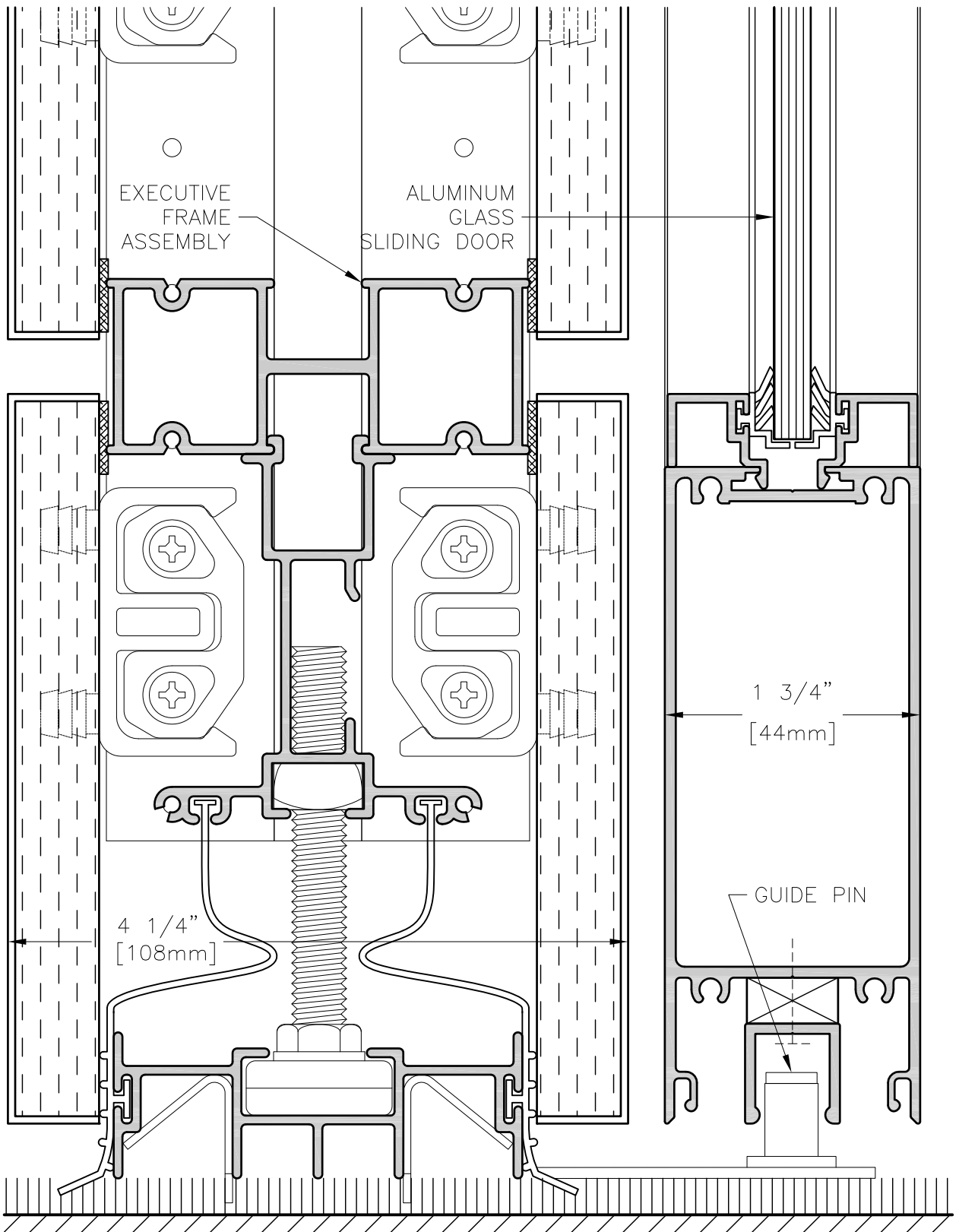

PARTITION SYSTEMS

GLASS SLIDING DOOR
SOLID PANEL
AT FLOOR

DWG:

E6.1.2

FILE: E6-1-2.DWG

SCALE: 1 : 1

DATE: NOV 2008

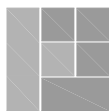
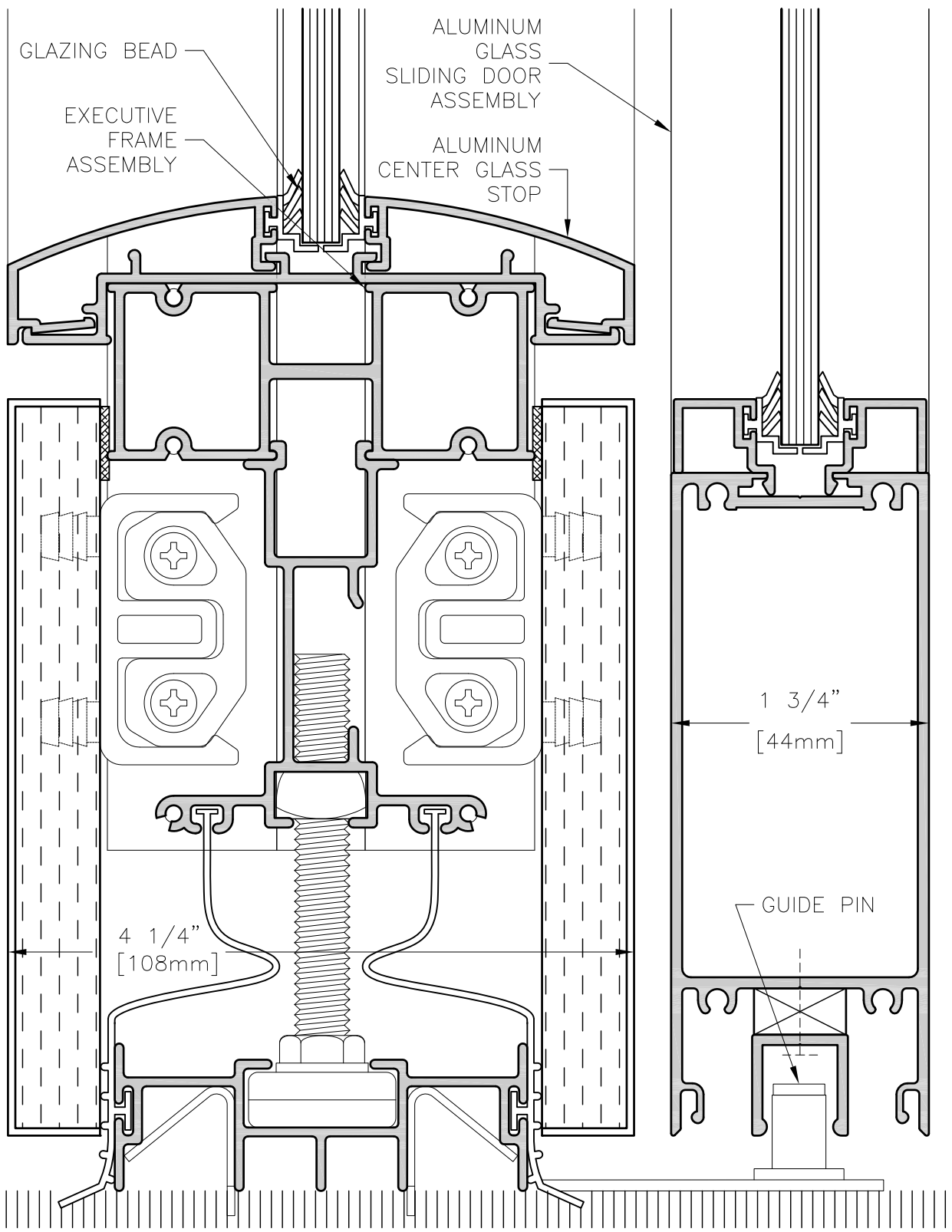

PARTITION SYSTEMS

GLASS SLIDING DOOR
ON GLASS
AT FLOOR

DWG:

E6.1.3

FILE: E6-1-3.DWG

SCALE: 1 : 1

DATE: NOV 2008

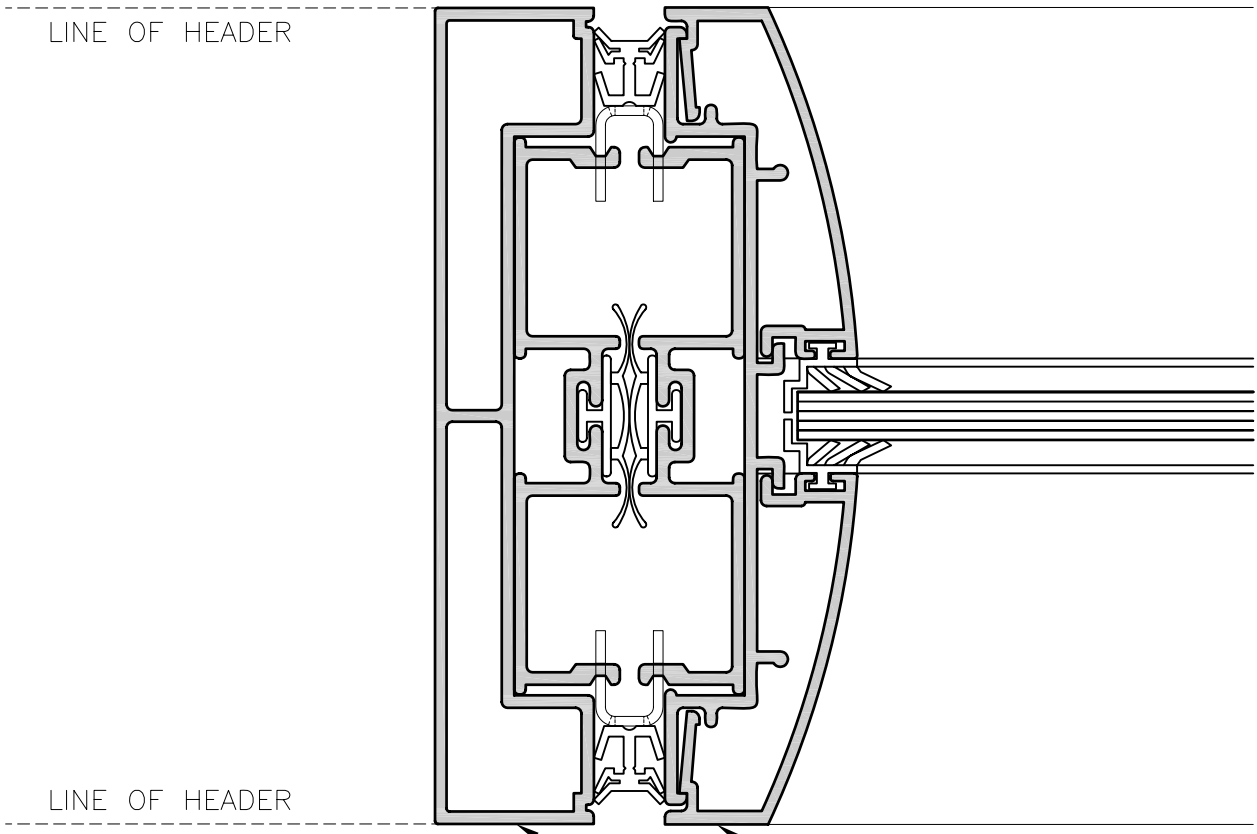
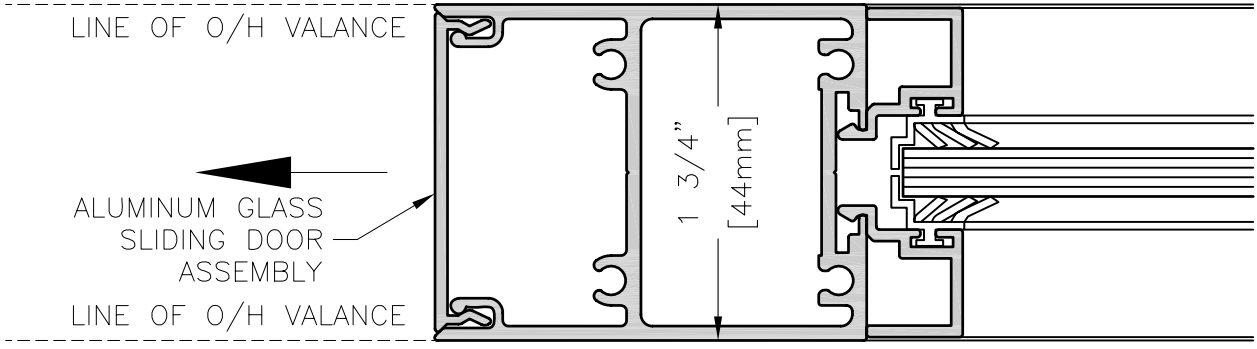

PARTITION SYSTEMS

GLASS SLIDING DOOR
OUTSIDE JAMB

DWG:

E6.1.4

FILE: E6-1-4.DWG

SCALE: 1 : 1

DATE: NOV 2008

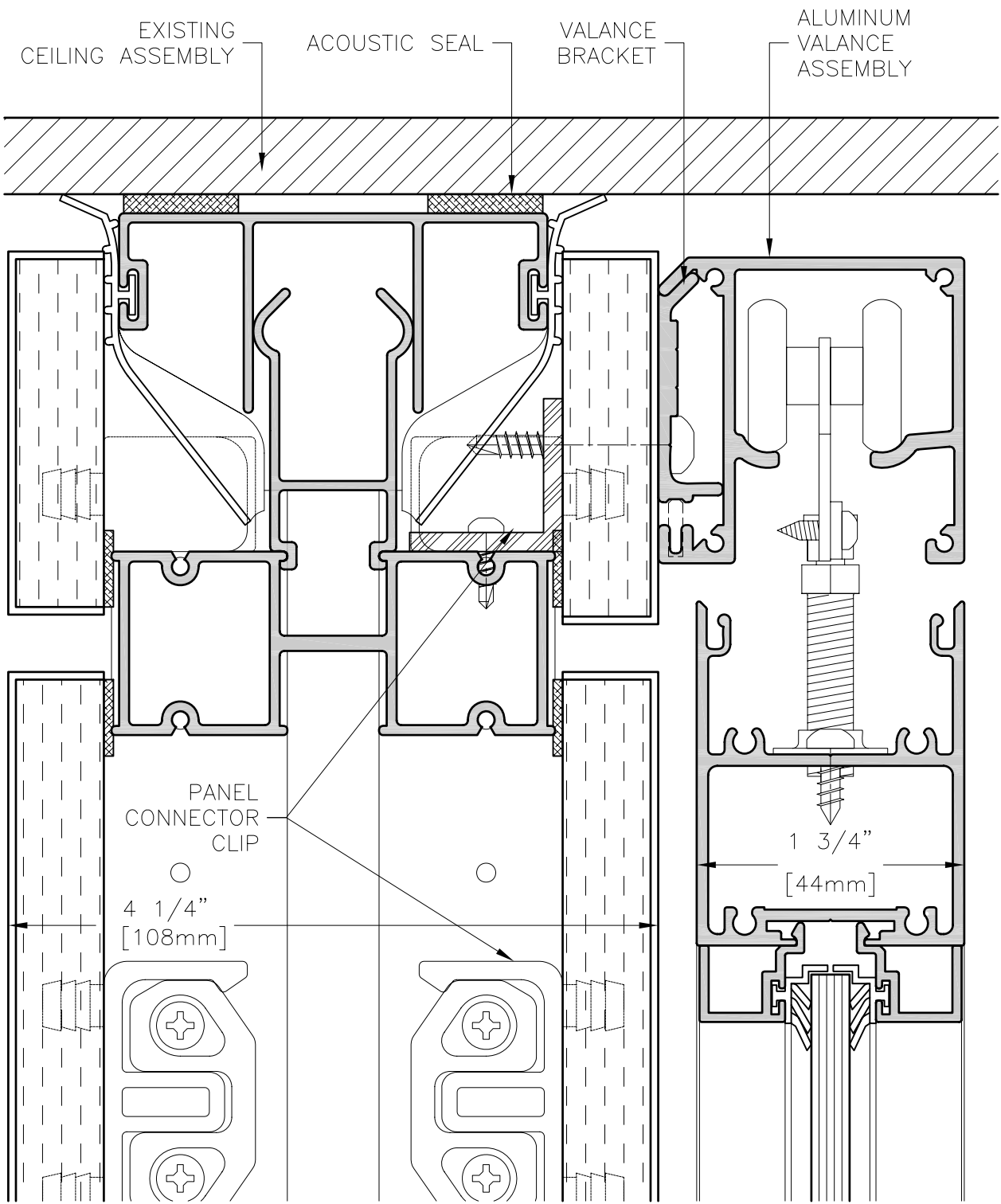

PARTITION SYSTEMS

GLASS SLIDING DOOR
ON SOLID
AT CEILING

DWG:

E6.1.5

FILE: E6-1.DWG

SCALE: 1 : 1

DATE: MAR 2009

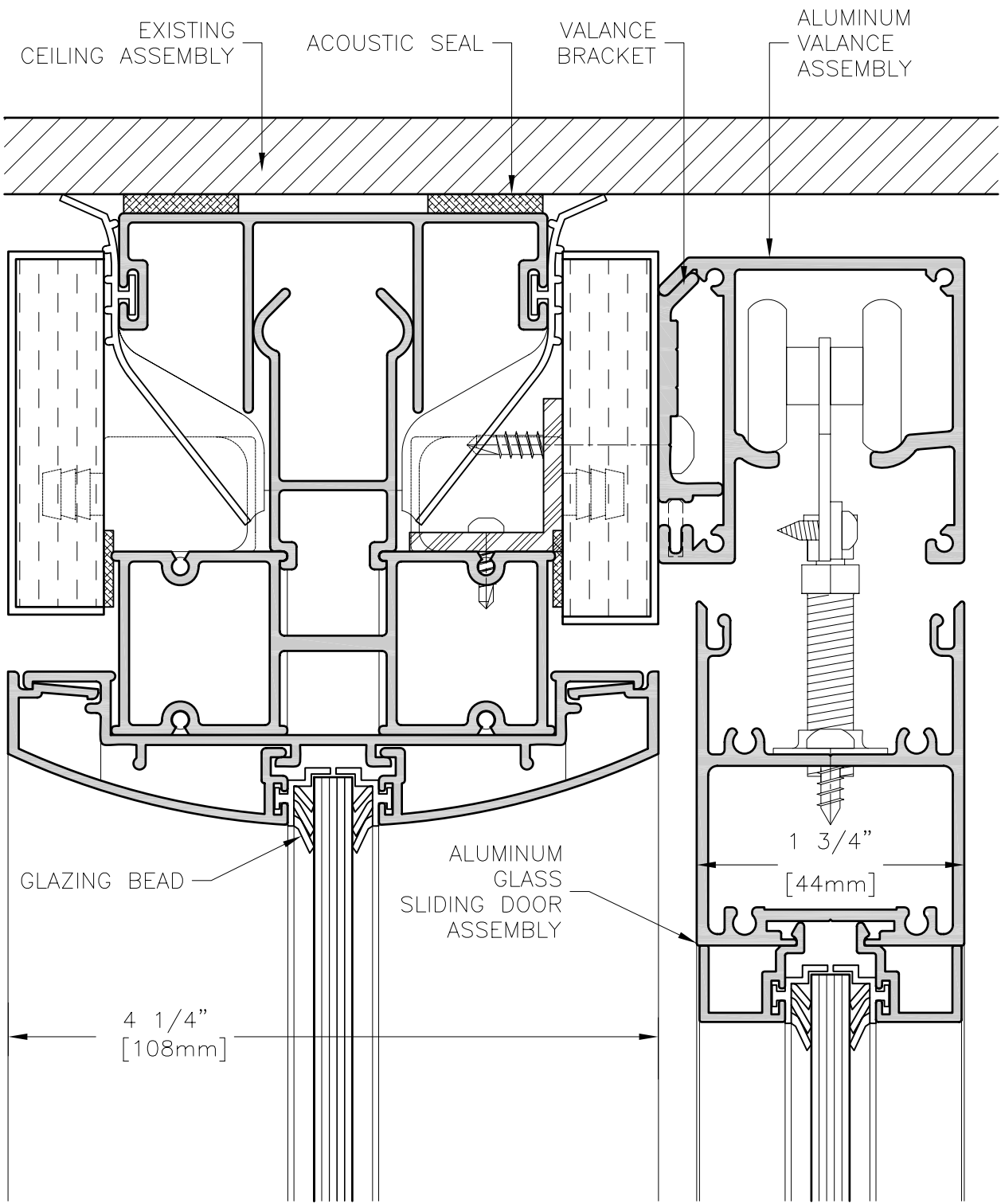

PARTITION SYSTEMS

GLASS SLIDING DOOR
ON SINGLE GLASS
AT CEILING

DWG:

E6.1.6

FILE: E6-1.DWG

SCALE: 1 : 1

DATE: MAR 2009

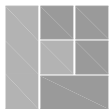
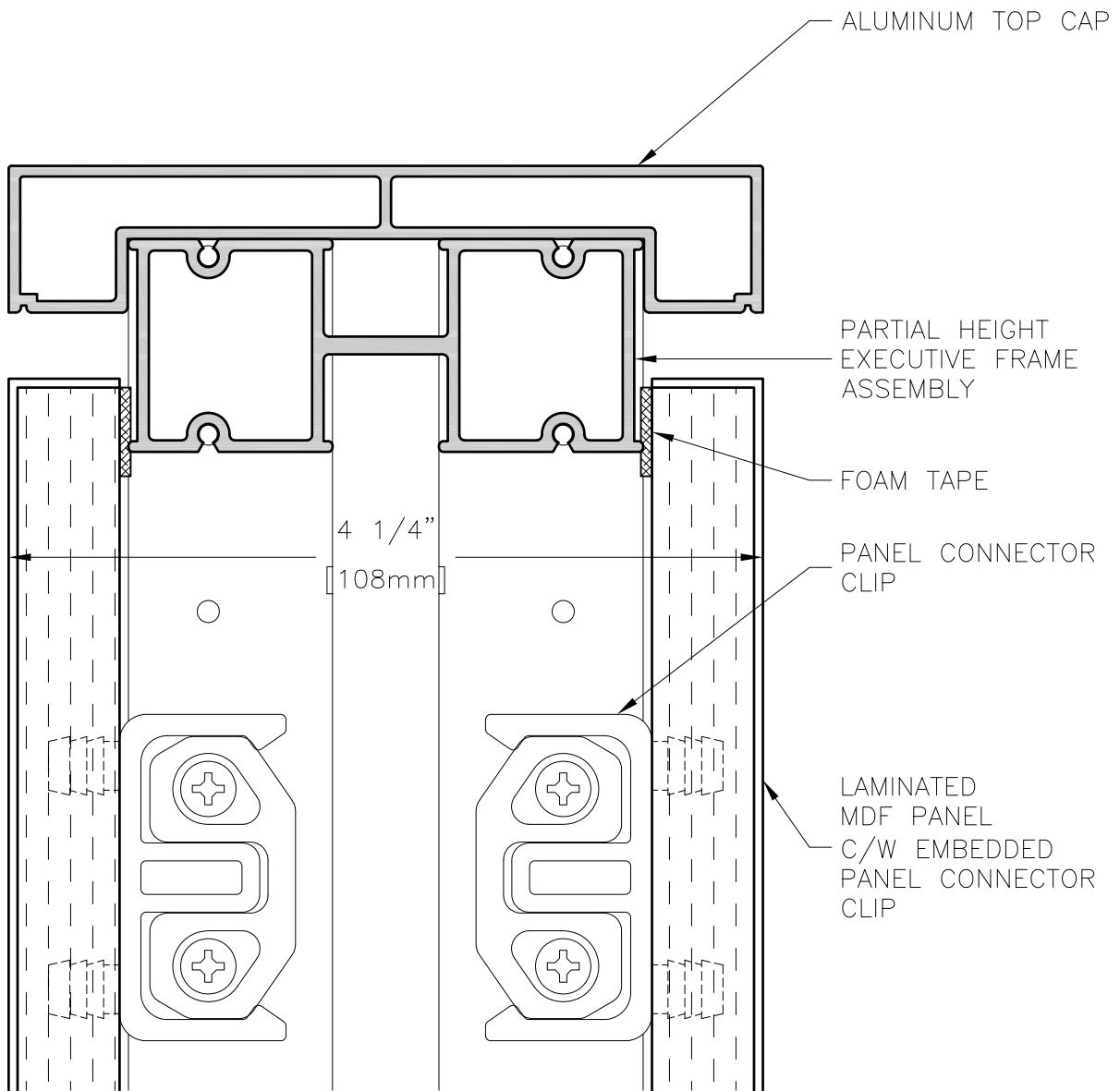

**PARTITION
SYSTEMS**

ALUMINUM TOP CAP
SOLID PANEL

DWG:

E7.1.1

FILE: E7-1-1.DWG

SCALE: 1 : 1

DATE: NOV 2008

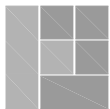
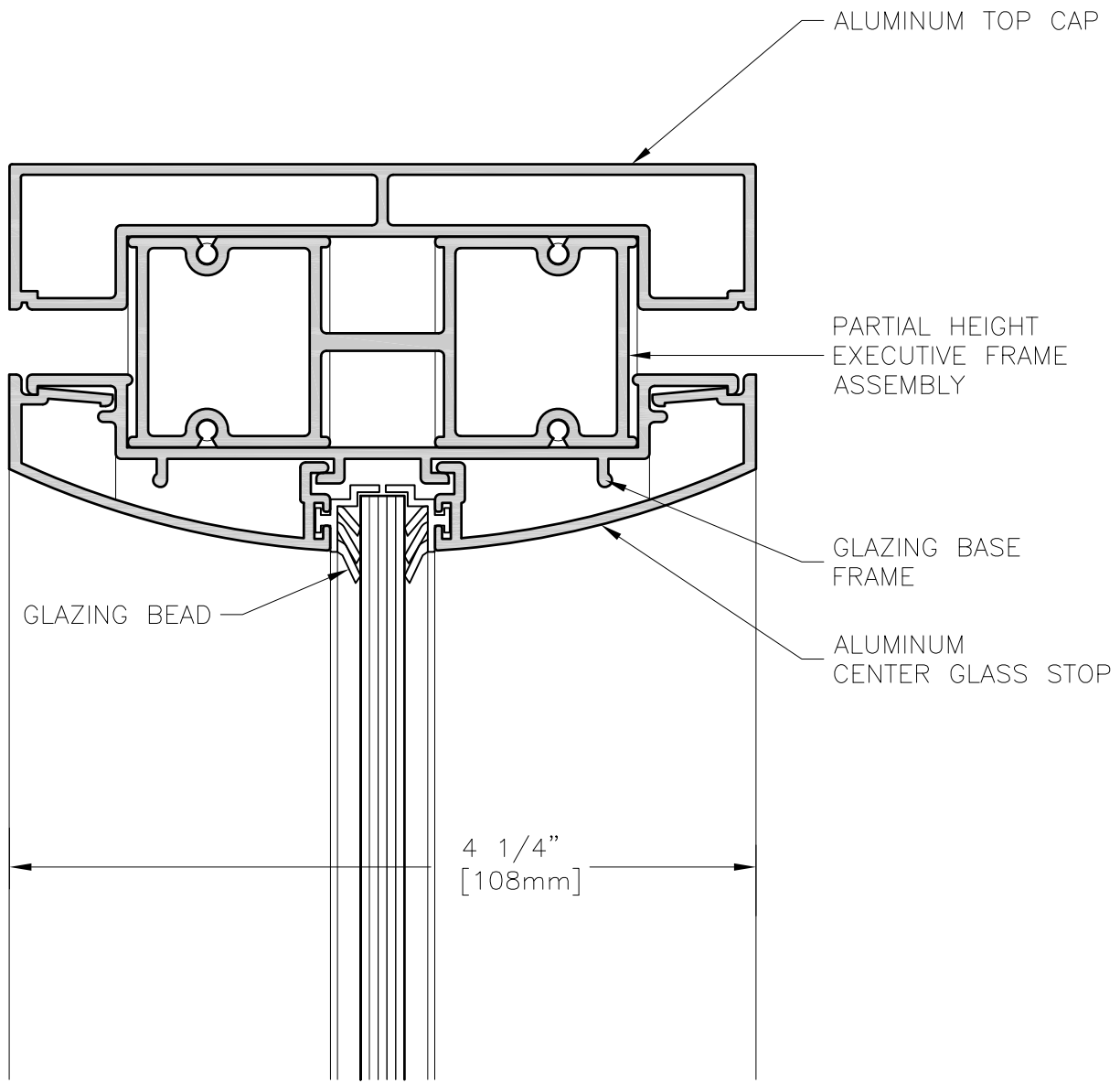

**PARTITION
SYSTEMS**

ALUMINUM TOP CAP
GLASS PANEL

DWG:

E7.1.2

FILE: E7-1-2.DWG

SCALE: 1 : 1

DATE: NOV 2008

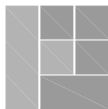
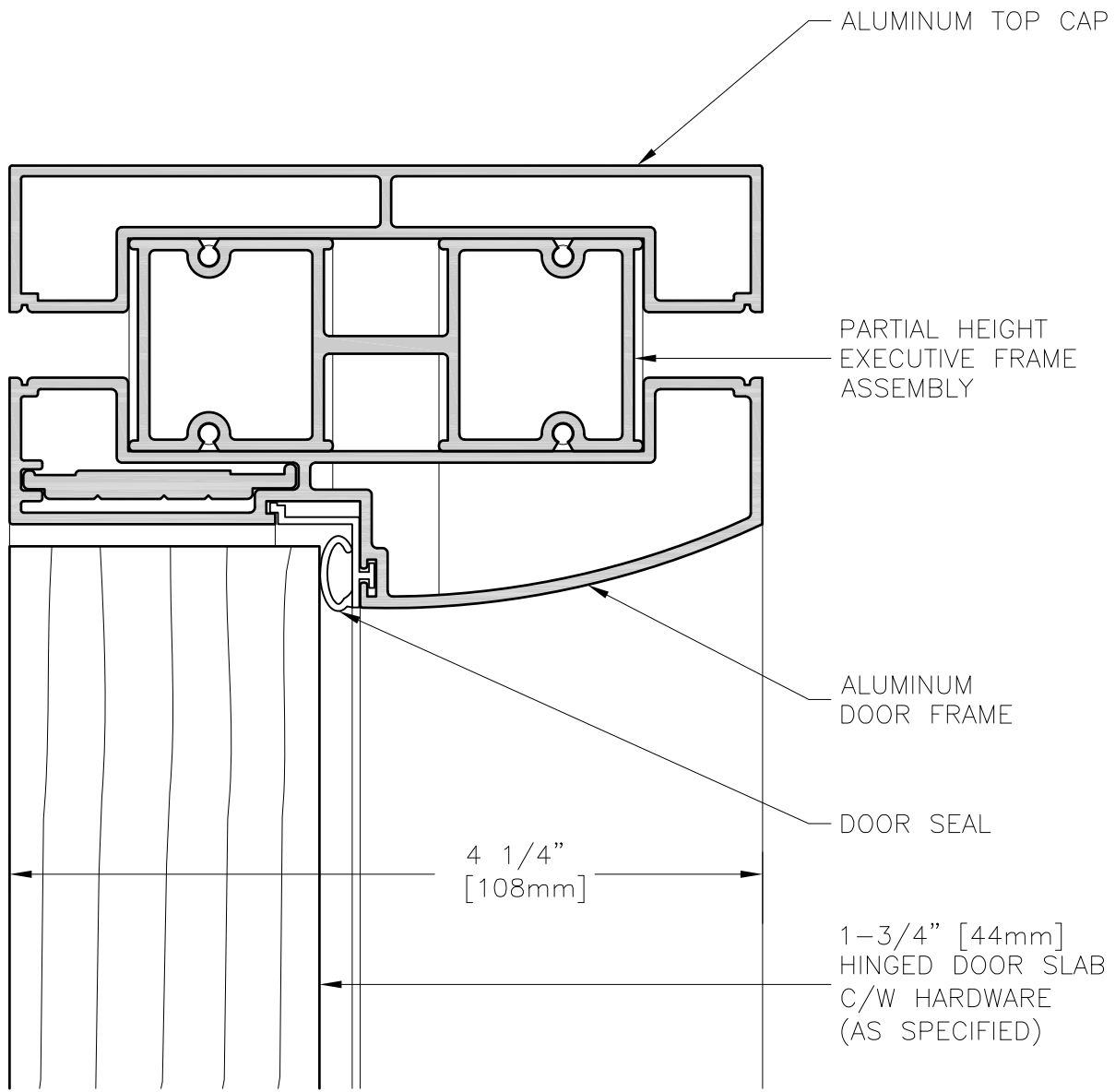

PARTITION SYSTEMS

ALUMINUM TOP CAP
DOOR PANEL

DWG:

E7.1.3

FILE: E7-1-3.DWG

SCALE: 1 : 1

DATE: NOV 2008

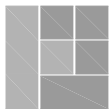
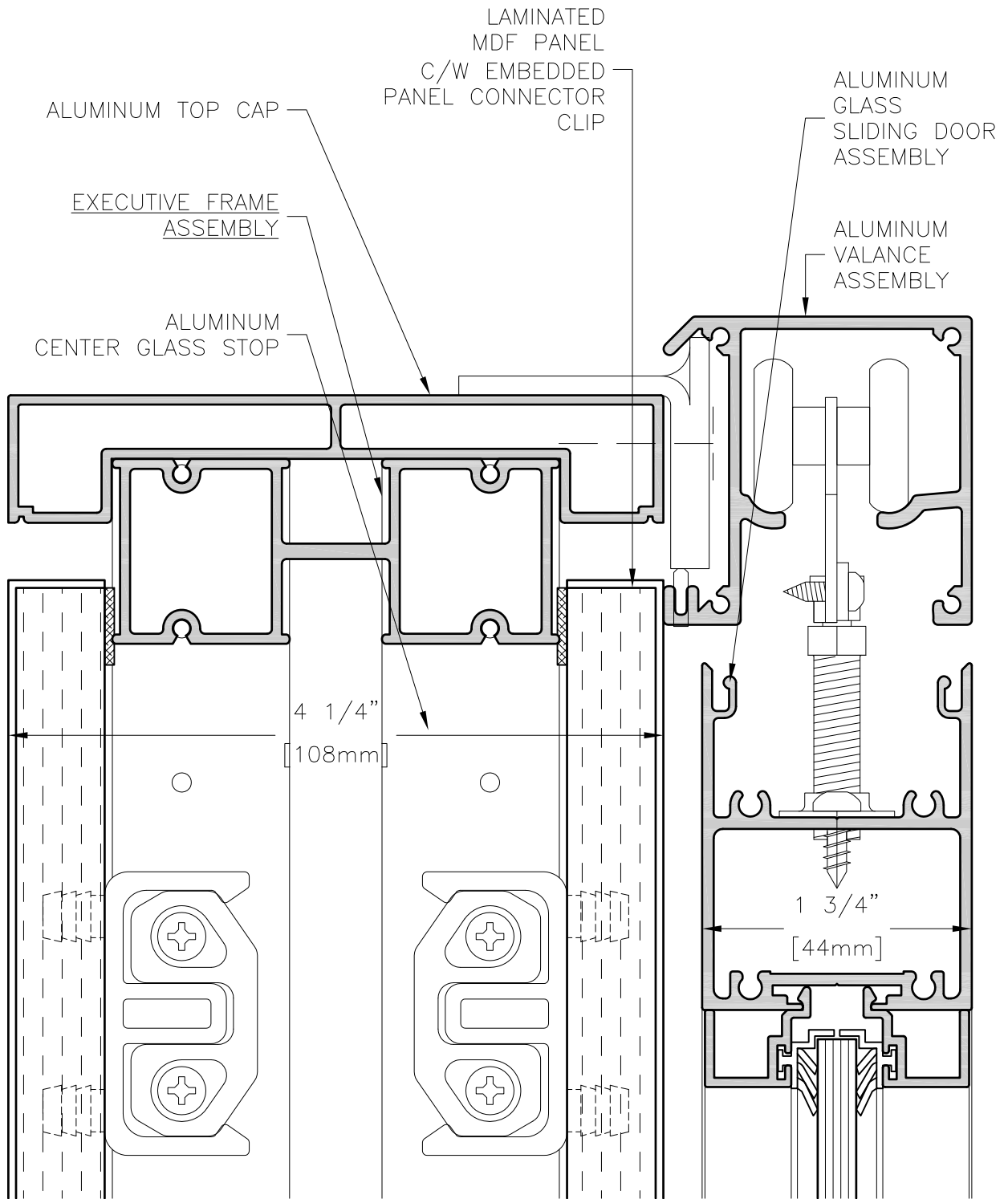

**PARTITION
SYSTEMS**

GLASS SLIDING DOOR
ALUMINUM TOP CAP
SOLID PANEL

DWG:

E7.1.4

FILE: E7-1-4.DWG

SCALE: 1 : 1

DATE: NOV 2008

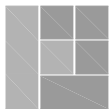
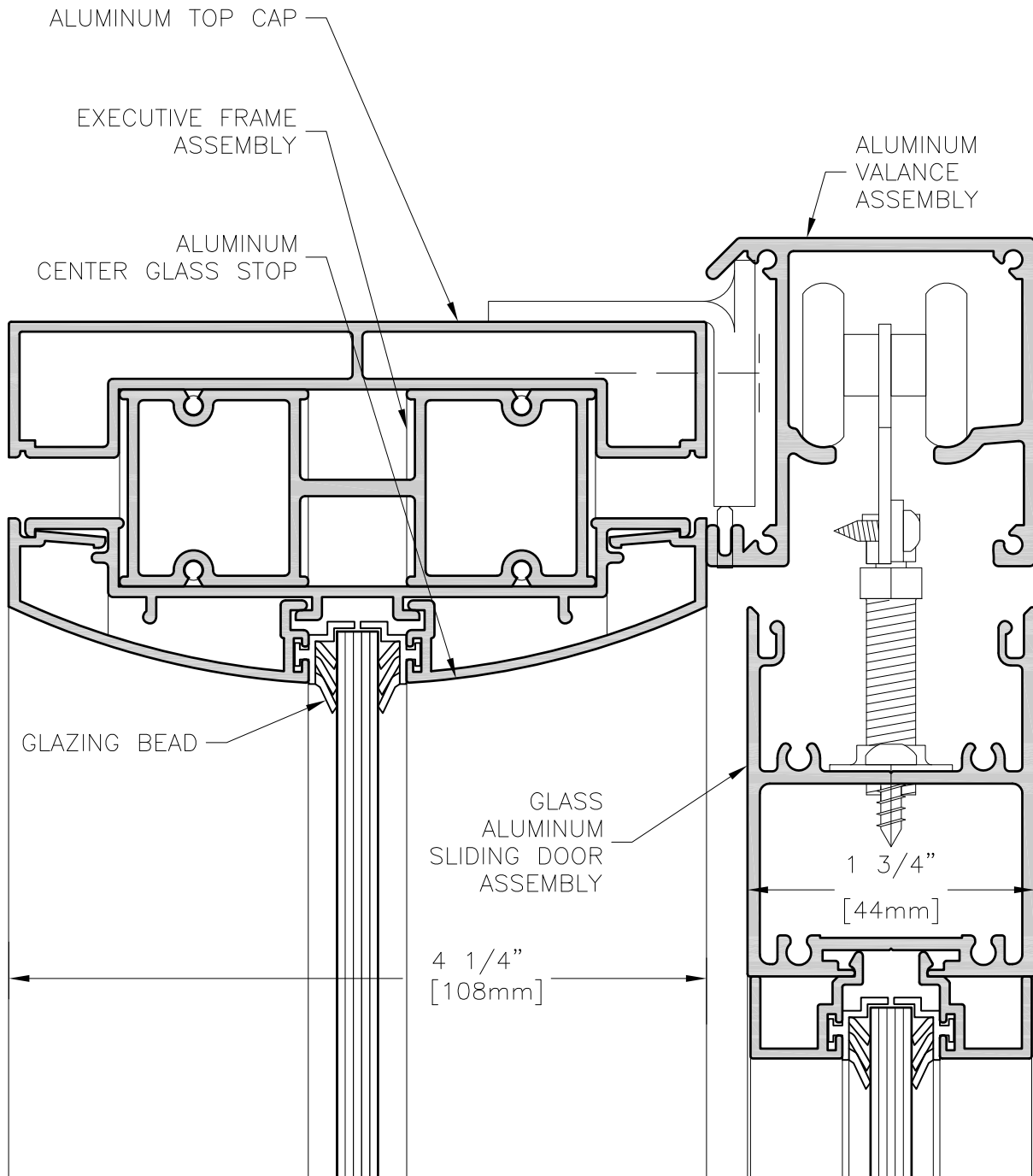

**PARTITION
SYSTEMS**

GLASS SLIDING DOOR
ALUMINUM TOP CAP
GLASS PANEL

DWG:

E7.1.5

FILE: E7-1-5.DWG

SCALE: 1 : 1

DATE: NOV 2008

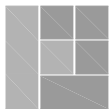
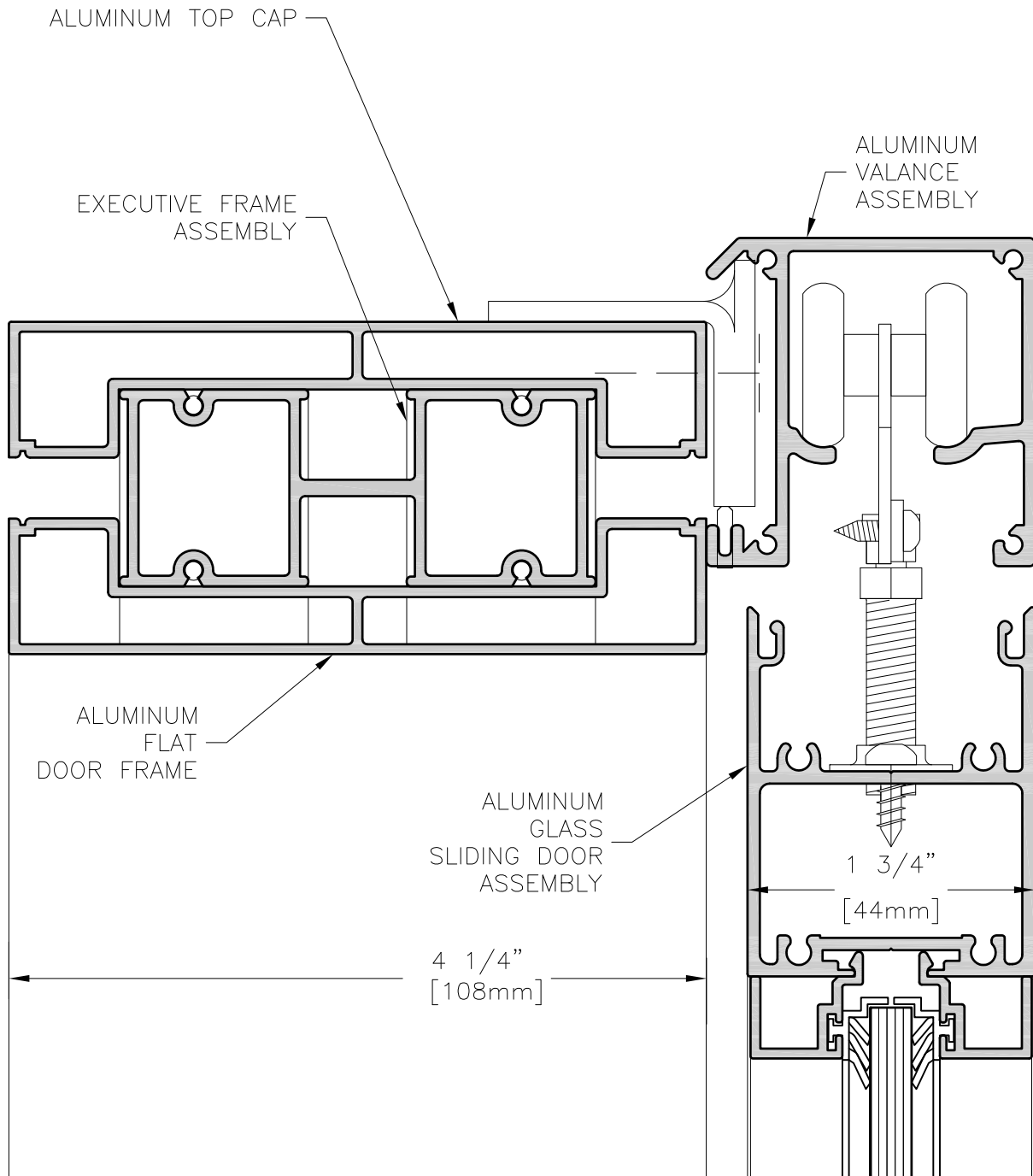

**PARTITION
SYSTEMS**

GLASS SLIDING DOOR
ALUMINUM TOP CAP
FLAT DOOR FRAME

DWG:

E7.1.6

FILE: E7-1-6.DWG

SCALE: 1 : 1

DATE: NOV 2008

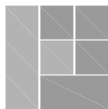
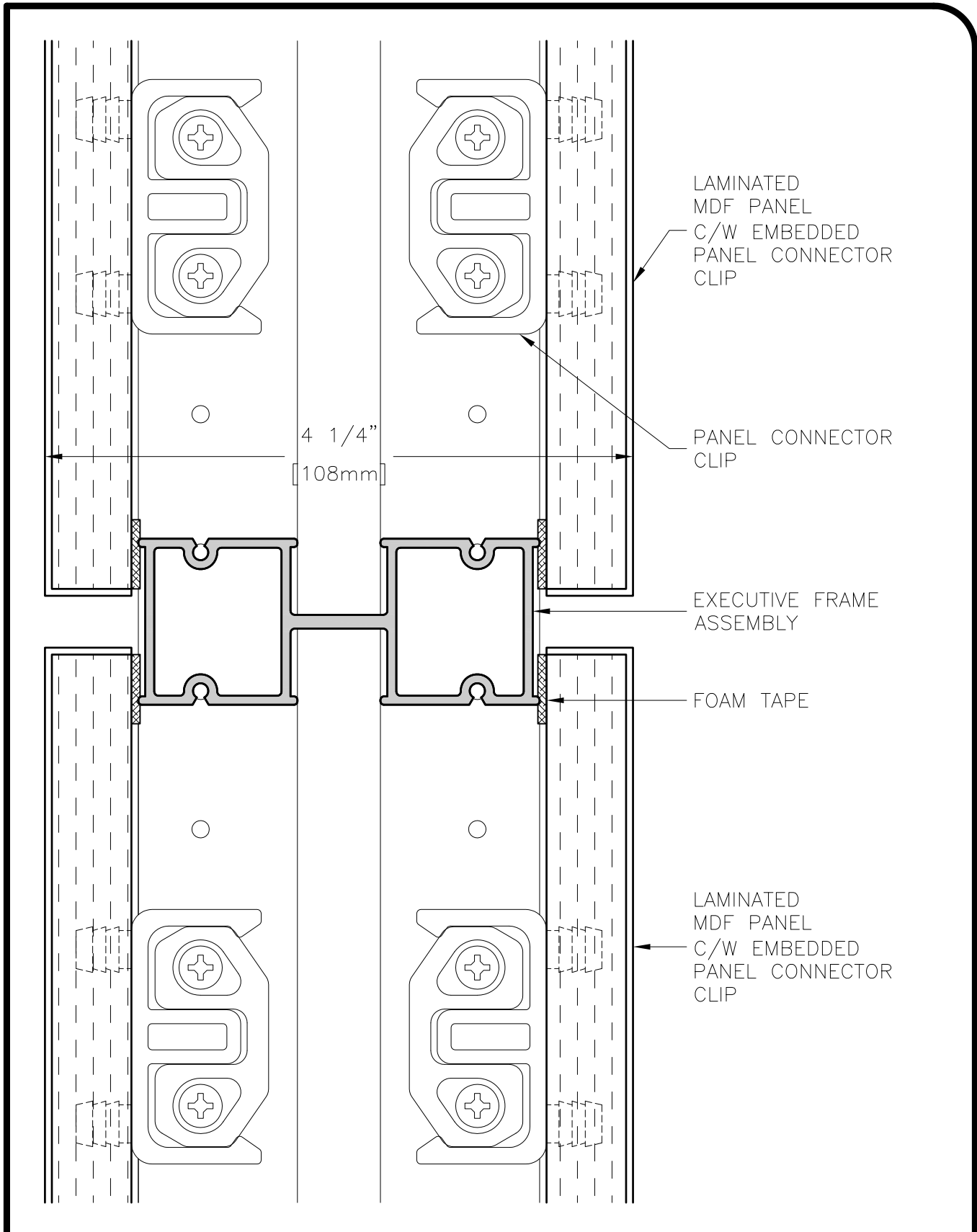

**PARTITION
SYSTEMS**

STACKED PANEL
SOLID ABOVE SOLID

DWG:

E7.2.1

FILE: E7-2-1.DWG

SCALE: 1 : 1

DATE: NOV 2008

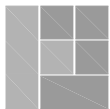
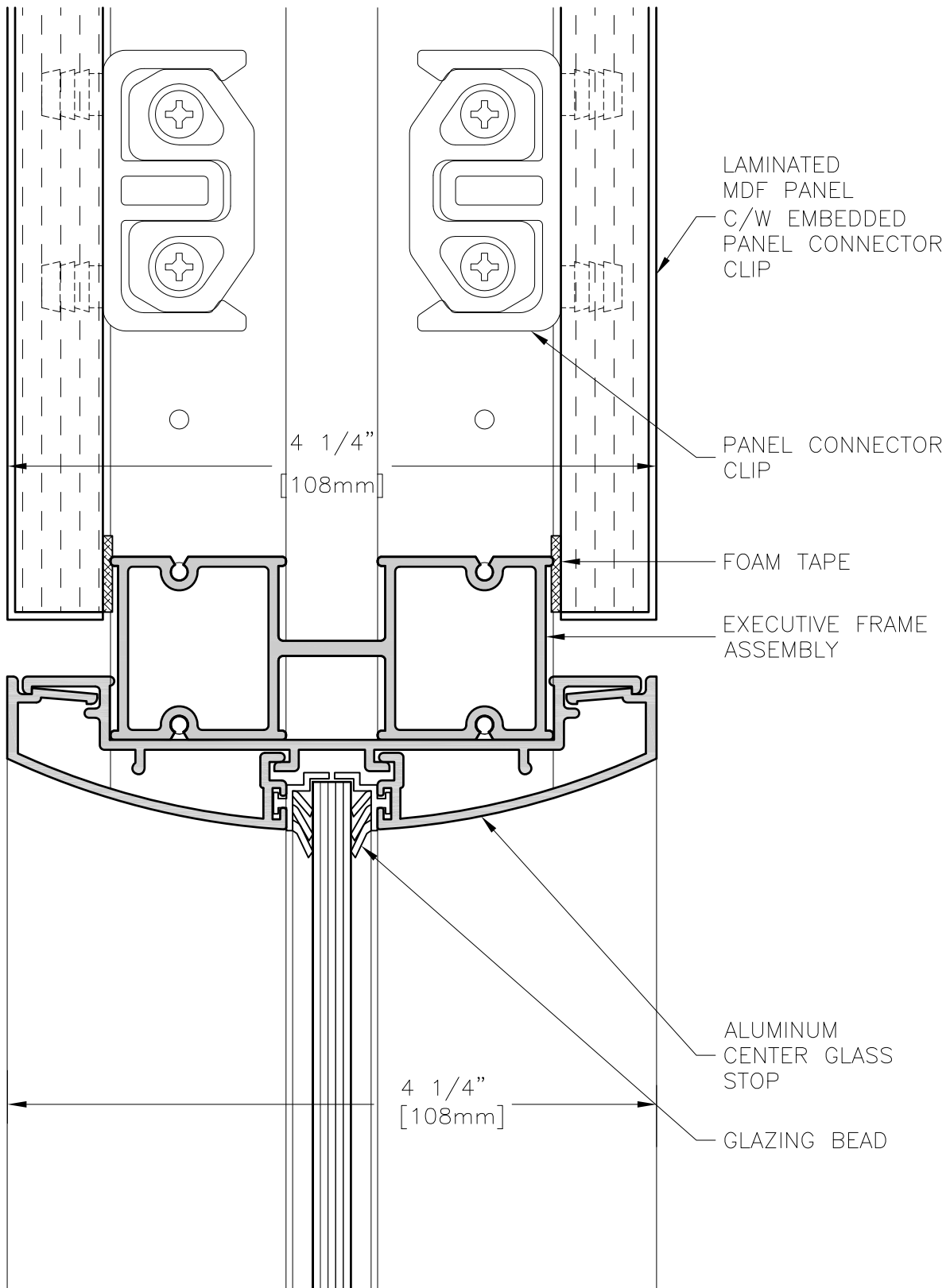

**PARTITION
SYSTEMS**

STACKED PANEL
SOLID ABOVE GLASS

DWG:

E7.2.2

FILE: E7-2-2.DWG

SCALE: 1 : 1

DATE: NOV 2008

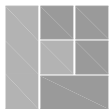
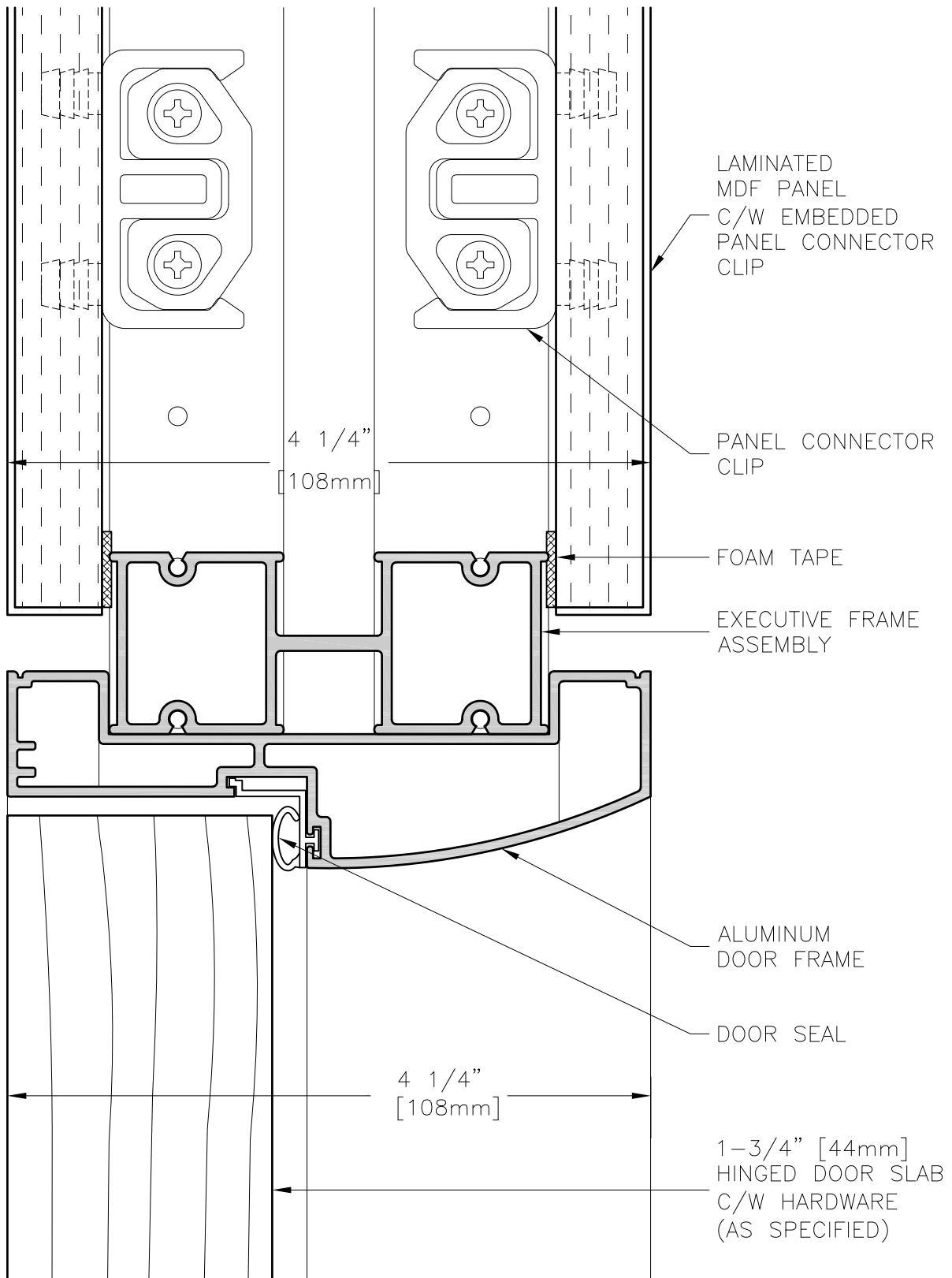

**PARTITION
SYSTEMS**

STACKED PANEL
SOLID ABOVE DOOR

DWG:

E7.2.3

FILE: E7-2-3.DWG

SCALE: 1 : 1

DATE: NOV 2008

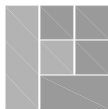
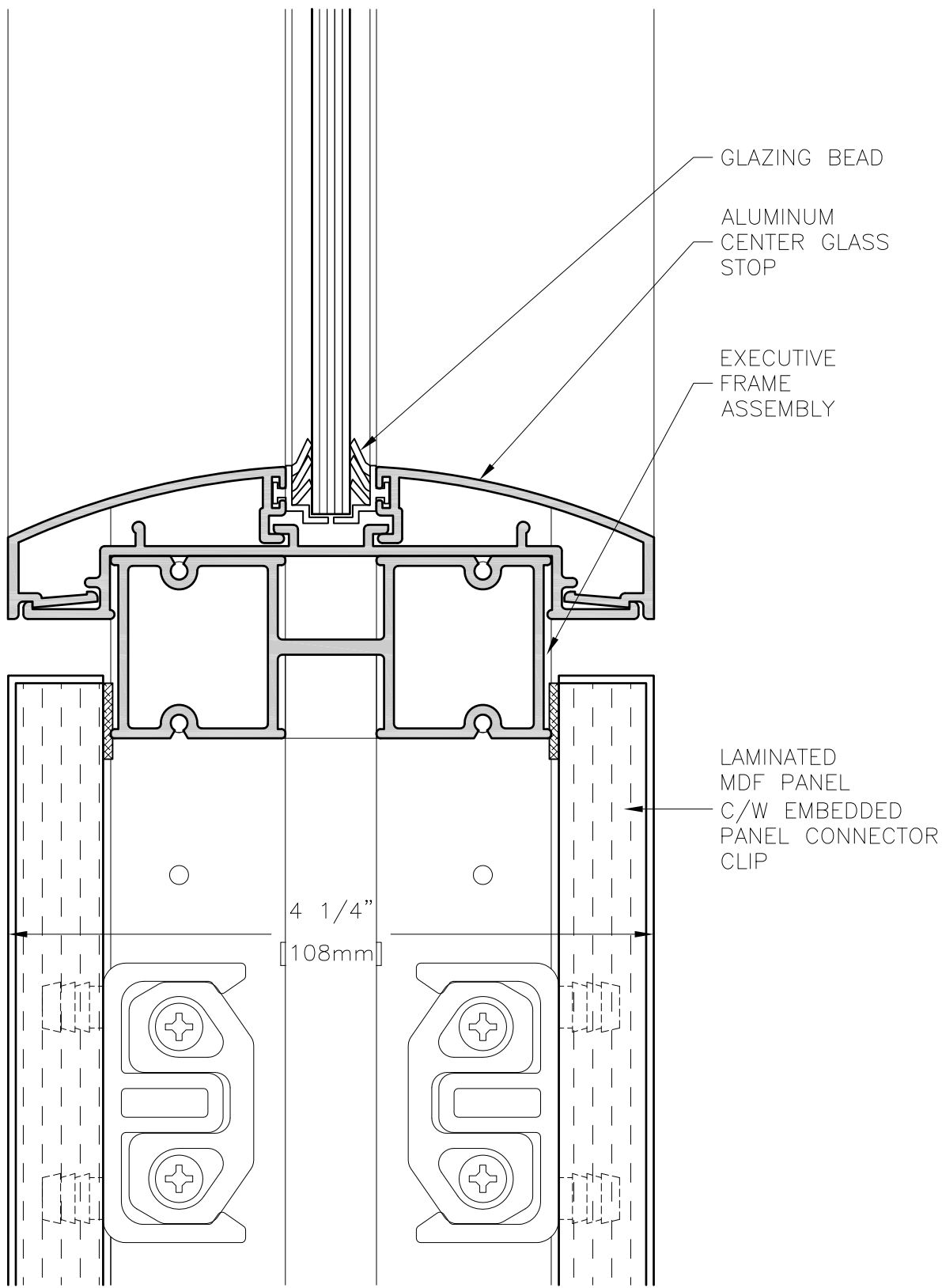

PARTITION SYSTEMS

STACKED PANEL
GLASS ABOVE SOLID

DWG:

E7.2.4

FILE: E7-2-4.DWG

SCALE: 1 : 1

DATE: NOV 2008

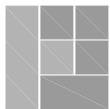
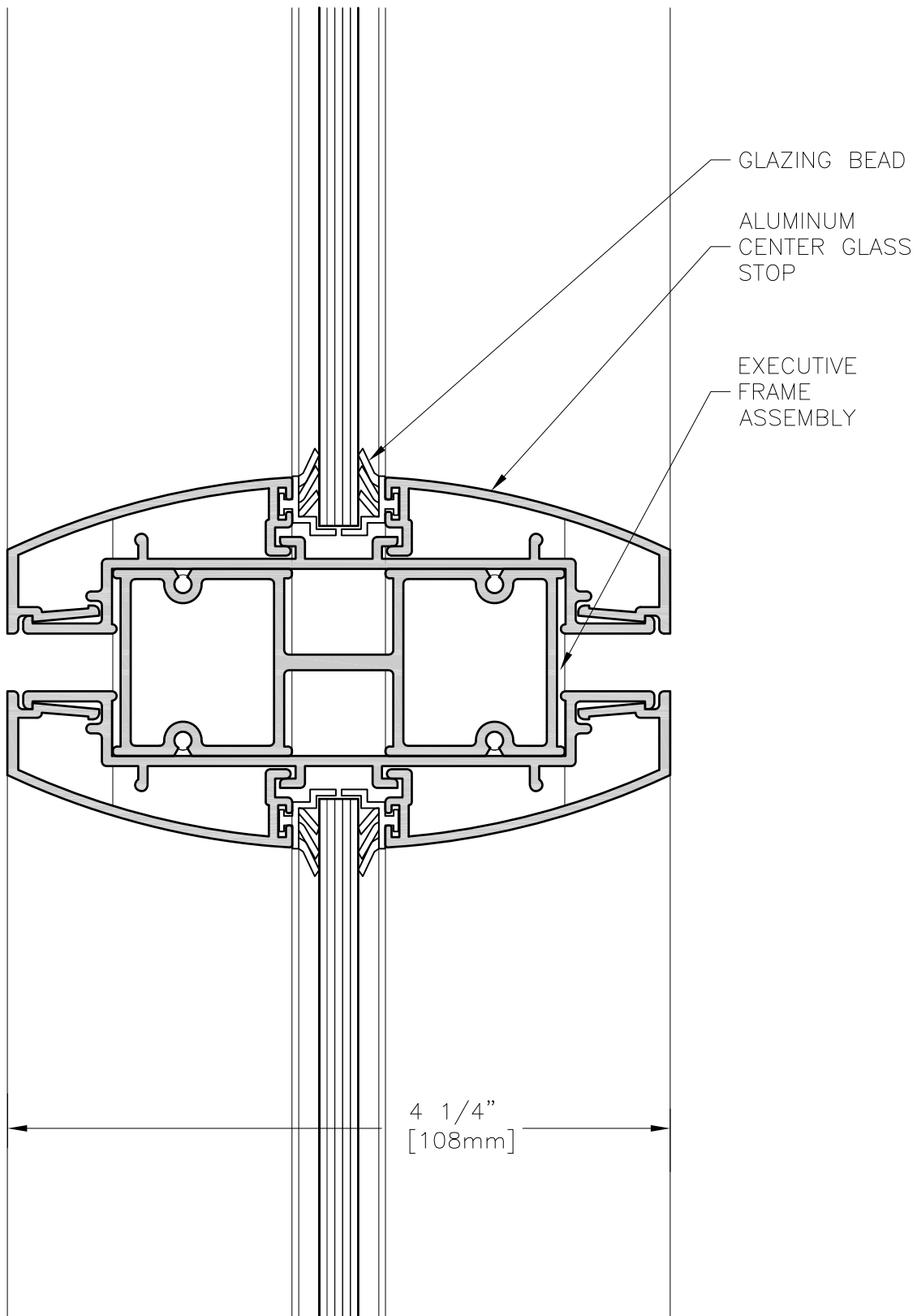

**PARTITION
SYSTEMS**

STACKED PANEL
GLASS ABOVE GLASS

DWG:

E7.2.5

FILE: E7-2-5.DWG

SCALE: 1 : 1

DATE: NOV 2008

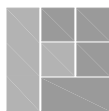
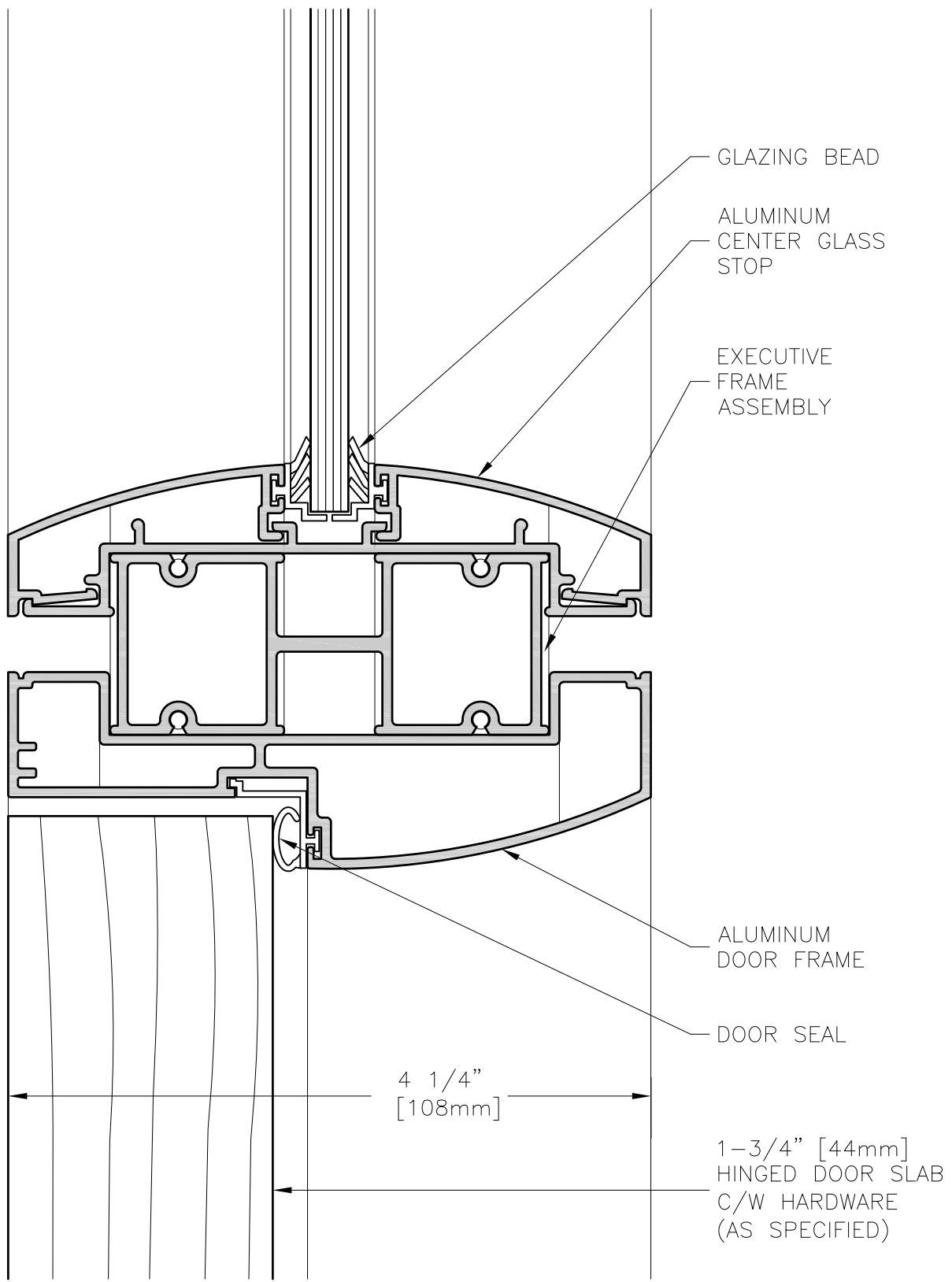

**PARTITION
SYSTEMS**

STACKED PANEL
GLASS ABOVE DOOR

DWG:

E7.2.6

FILE: E7-2-6.DWG

SCALE: 1 : 1

DATE: NOV 2008